

experience

function

quality

style

technology



8th edition V2

grab rail manual





CLAM FLANGE™

This symbol confirms the grab rail as represented is manufactured with a pre-formed 78 mm snap on domed cover with a 5 degree radius to comply with clause 17 of AS 1428.1-2009 for Design and Construction.

FEATURES & BENEFITS PAGE 28



HYGIENIC SEAL®

This symbol confirms the grab rail as represented is fabricated with Con-Serv's own 50 mm (TPE) fitted flange HYGIENIC SEAL®. The flange is designed with a 5 degree radius to comply with clause 17 of AS 1428.1-2009 for Design and Construction.

FEATURES & BENEFITS PAGE 29



LINEAR

This symbol confirms the grab rail as represented is fabricated with Con-Serv's "T" leg Linear flange. The flange is designed with a 5 degree radius to comply with clause 17 of AS 1428.1-2009 for Design and Construction.

FEATURES & BENEFITS PAGE 43



DIMENSIONAL COMPLIANT

This symbol when exhibited confirms that the item complies with the dimensional requirements of AS 1428.1-2009 for installation where applicable in water closets, 2 walled shower enclosure.



PWD SHOWER COMPLIANT - 2

This symbol when exhibited, confirms that the grab rail handshower kit complies **strictly** with all requirements of AS 1428.1-2009 for a 2 walled shower enclosure for People with Disabilities (PWD).

® and TM

Indicate trademarks of Con-Serv Corporation Australia Pty Ltd.

OUR PROMISE

Con-Serv Corporation Australia Pty Ltd warrants all products to be free from manufacturing defects for 5 years from date of purchase. Con-Serv will repair or replace defective items if defects occur in normal use. Con-Serv will not be liable for defects arising through normal wear and tear. Item(s) must be returned with proof of purchase to Con-Serv at 17 Glentanna Street, Kedron, Queensland 4031. We will attend to your warranty claim after we make appropriate investigations. Contact our Service Manager during normal office hours on 1300 467 322 or at our email address of warranty@con-serv.com.au. If a warranty claim is accepted, Con-Serv will bear the reasonable costs of the return of the defective item(s) to us. A claim for expenses associated with making a claim for a defective product must be in writing and submitted to us with copies of supporting documents. The benefits given under our warranty are in addition to other rights and remedies of the customer under a law in relation to goods and services to which this warranty relates. Our goods come with guarantees that cannot be excluded under the Australian Consumer Law. You are entitled to a replacement or a refund for a major failure and compensation for any other reasonable foreseeable loss or damage. You are also entitled to have the goods repaired or replaced if the goods fail to be of acceptable quality and the failure does not amount to a major failure.



Bathrooms

Bathroom Accessories - Modena Collection	2-3
Bathroom Accessories - Comfort Collection	4-7
Bathroom Baskets	8
Bathroom Rails - 25 mm Comfort Collection	9

Shower Systems For Healthcare Applications

HOSFAB® - Commercial Healthcare Kits.....	14-17
HOSFAB® - Standard Healthcare Kits	18-21
HOSFAB® - Premium Healthcare Kits.....	22-25
HOSFAB® - People With Disabilities (PWD) Kits	12-13
Healthcare Kit Accessories.....	26



Grab Rails

SAFE-ASSIST® - Regular - Straight Grab Rails	30-31
SAFE-ASSIST® - Regular - Toilet Assist Grab Rails	32-33
SAFE-ASSIST® - Regular - Corner Grab Rails	34
SAFE-ASSIST® - Regular - Shower Recess Grab Rails	35
SAFE-ASSIST® - Premium - Straight Grab Rails.....	36-37
SAFE-ASSIST® - Premium - Toilet Assist Grab Rails.....	38-39
SAFE-ASSIST® - Premium - Corner Grab Rails.....	40
SAFE-ASSIST® - Premium - Shower Recess Grab Rails	41
SAFE-ASSIST® - Premium - Towel Rail / Grab Rail Combination	42
SAFE-ASSIST® - Premium - Linear Grab Rail Options.....	43
SAFE-ASSIST® - TILTLOCK® - Lock-Up / Lock-Down Folding Rail-Ways®	44
SAFE-ASSIST® - SWINGLOCK® - Side Swing Grab Rail.....	45
SAFE-ASSIST® - Folding Shower Seats.....	46-47
SAFE-ASSIST® - Backrest Toilet Support Options	48-49
SAFE-ASSIST® - Anti-Ligature Grab Rails	50-51
Rail-Ways® - Accessories.....	27

Technical Product Information









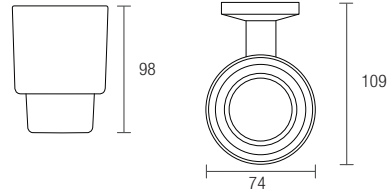

CLAM™ Flange Information Page.....	28
HYGIENIC SEAL® Information Page	29
Circulation Space in Toilets/Water Closets	52
Options for Use in Toilets/Water Closets	53
Systems for PWD - 2 Walled Shower Enclosure	54
Options for Use in 2 Walled Shower Enclosure	55
Systems for PWD - To Suit Combined Sanitary Compartment	56
Options for PWD - To Suit Combined Sanitary Compartment	57
Stainless Steel Information Page.....	61
Warranty	Inside front cover

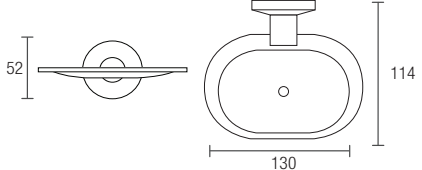

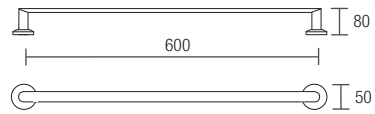

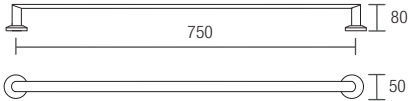

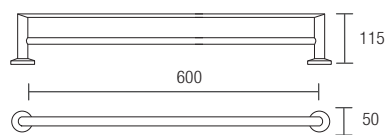

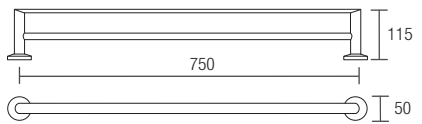
AVAILABILITY

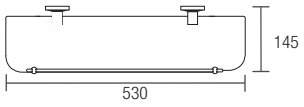

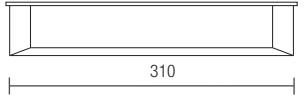

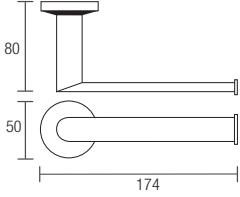

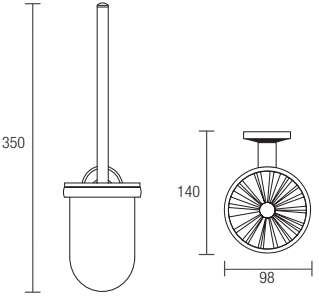

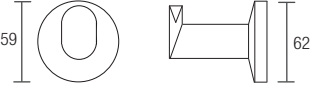

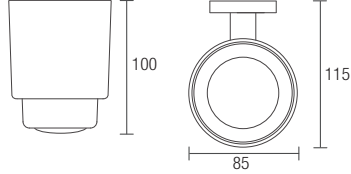
The items shown in this manual are generally ex-stock. For custom made configuration grab rails, allow 10 working days for fabrication and delivery. Returns and credit facilities are not available for these models.

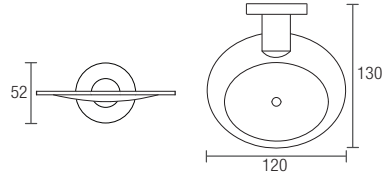

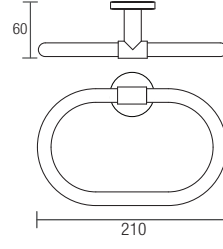

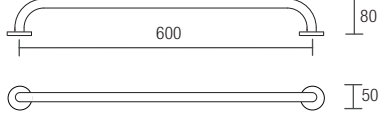

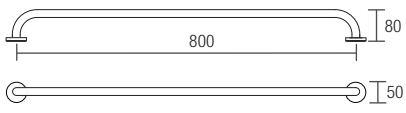
COPYRIGHT

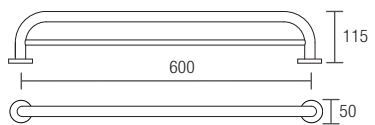

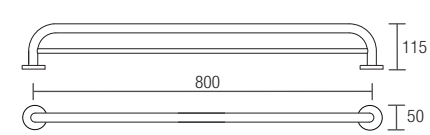

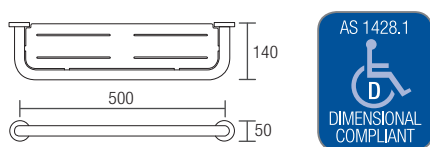
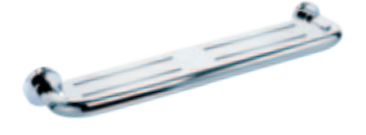
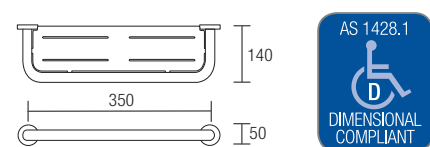

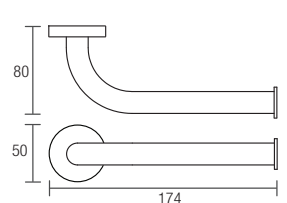
This document is Standards Australia Ltd copyrighted material that is distributed by SAI Global on Standards Australia Ltd's behalf. It may be reproduced in accordance with the terms of SAI Global Ltd's Licence 1108-c182 to Con-Serv Corporation Australia Pty. Ltd. All licensed copies of this document must be obtained from the Licensee. Standards Australia Ltd's material is not for resale, reproduction or distribution in whole or in part without written permission from SAI Global Ltd: tel +61 2 8206 6355 or copyright@saiglobal.com

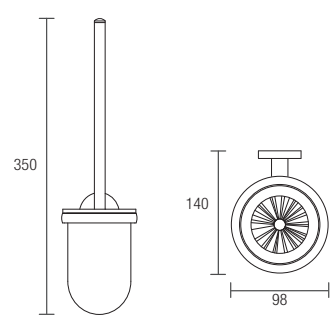
	Code	Finish	Features
BA 100 C - TUMBLER HOLDER			
	BA 100 C	Chrome	Chrome plated brass. Frosted glass tumbler.
	BA 700 G0	Spare part Glass only	
			
BA 101 C - SOAP DISH HOLDER			
	BA 101 C	Chrome	Chrome plated brass.
			
BA 104 C - 600 mm - 20 mm SINGLE TOWEL RAIL			
	BA 104 C	Chrome	600 mm \emptyset to \emptyset wall fixings. Chrome plated brass.
			
BA 105 C - 750 mm - 20 mm SINGLE TOWEL RAIL			
	BA 105 C	Chrome	750 mm \emptyset to \emptyset wall fixings. Chrome plated brass.
			
BA 106 C - 600 mm - 20 mm DOUBLE TOWEL RAIL			
	BA 106 C	Chrome	600 mm \emptyset to \emptyset wall fixings. Chrome plated brass.
			
BA 107 C - 750 mm - 20 mm DOUBLE TOWEL RAIL			
	BA 107 C	Chrome	750 mm \emptyset to \emptyset wall fixings. Chrome plated brass.
			

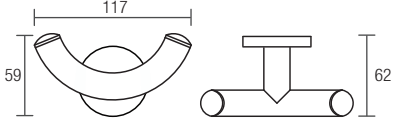
	Code	Finish	Features
BA 108 C - 530 mm X 10 mm CLEAR TEMPERED GLASS SHELF			
	BA 108 C	Chrome	530 mm x 10 mm clear tempered glass shelf. Brackets chrome plated brass. 
		Spare part	
	BA 729 B0	Barrier only	
BA 111 C - HAND TOWEL RAIL			
	BA 111 C	Chrome	280 mm Ø to Ø wall fixings. Chrome plated brass. 
BA 112 C - PAPER HOLDER			
	BA 112 C	Chrome	Chrome plated brass. 
BA 114 C - TOILET BRUSH WITH HOLDER			
	BA 114 C	Chrome	Brass made wall mounted toilet brush set with frosted glass bowl. 
BA 115 C - SINGLE ROBE HOOK			
	BA 115 C	Chrome	Chrome plated brass. 

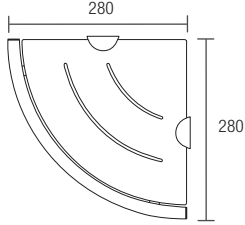

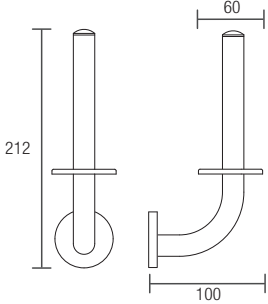
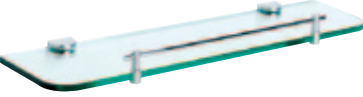
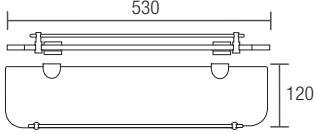

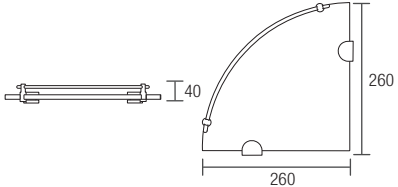



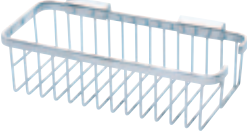
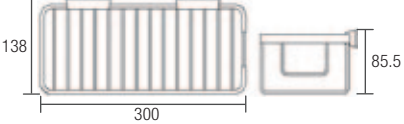

	Code	Finish	Features
BA 700 C - TUMBLER HOLDER			
	BA 700 C	Chrome	Chrome plated brass. Frosted glass tumbler
	BA 700 G0	Spare part Glass only	
			
BA 701 C - SOAP DISH HOLDER			
	BA 701 C	Chrome	Chrome plated brass.
			
BA 703 C - TOWEL RING			
	BA 703 C	Chrome	Chrome plated brass.
			
BA 704 C - 600 mm - 20 mm SINGLE TOWEL RAIL			
	BA 704 C	Chrome	600 mm Ø to Ø wall flange.
			
BA 705 C - 800 mm - 20 mm SINGLE TOWEL RAIL			
	BA 705 C	Chrome	800 mm Ø to Ø wall flange.
			
BA 706 C - 600 mm - 20 mm DOUBLE TOWEL RAIL			
	BA 706 C	Chrome	600 mm Ø to Ø wall flange.
			

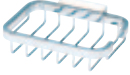
	Code	Finish	Features
BA 707 C - 800 mm - 20 mm DOUBLE TOWEL RAIL			
	BA 707 C	Chrome	800 mm Ø to Ø wall fixings.
			
BA 708 C - 500 mm - STAINLESS STEEL SHELF WITH 20 mm PROTECTIVE BARRIER			
	BA 708 C	Polish Supreme	500 mm Ø to Ø wall fixings. Complies as per requirements of AS 1428.1-2009 section 15.4.2 (B2) Shelves. External to circulation space.
			
BA 710 C - 350 mm - STAINLESS STEEL SHELF WITH 20 mm PROTECTIVE BARRIER			
	BA 710 C	Polish Supreme	350 mm Ø to Ø wall fixings. Complies as per requirements of AS 1428.1-2009 section 15.4.2 (B1) Shelves. Within circulation space.
			
BA 712 C - PAPER HOLDER			
	BA 712 C	Chrome	Chrome plated brass.
			
BA 714 C - TOILET BRUSH WITH HOLDER			
	BA 714 C	Chrome	Brass made wall mounted toilet brush set with frosted glass bowl.
			
		Spare parts	
	BA 714 B0	Brush head only	
	BA 714 G0	Glass only	
	BA 714 BH	Handle only	

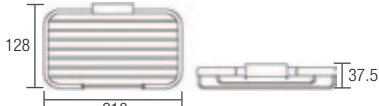
	Code	Finish	Features
BA 715 C - DOUBLE ROBE HOOK			
	BA 715 C	Chrome	Chrome plated brass.
			
BA 718 C - STAINLESS STEEL CORNER SHELF WITH 20 mm PROTECTIVE BARRIER			
	BA 718 C	Polish Supreme	280 mm x 280 mm x 90° with floating mount brackets.
			
BA 721 C - SPARE PAPER HOLDER			
	BA 721 C	Chrome	Chrome plated brass.
			
BA 729 C - 530 mm x 10 mm GLASS VANITY SHELF			
	BA 729 C	Chrome - with Barrier	Brass made mounting brackets. 530 mm x 120 mm x 10 mm clear tempered glass shelf.
			
BA 739 C - 260 mm x 10 mm GLASS CORNER SHELF			
	BA 739 C	Chrome - with barrier	260 mm radius, 10 mm clear tempered glass with brass integrated barrier rail and wall mounts.
		Spare parts	
	BA 739 B0	Barrier only	
	BA 769 C	Mount brackets - pair	
			

BATHROOM BASKETS - COMFORT COLLECTION

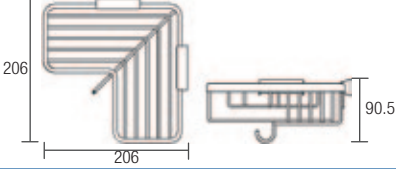
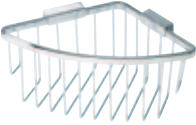

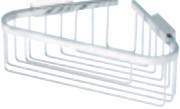
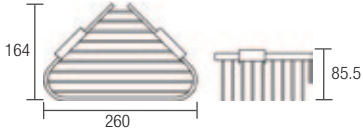
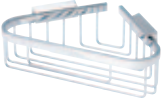
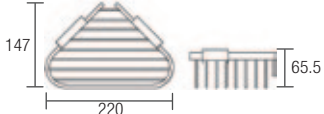
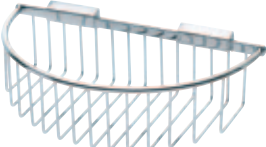
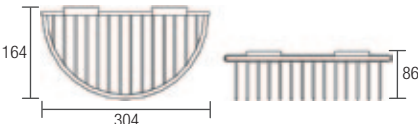







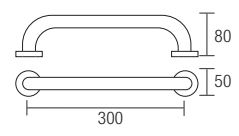

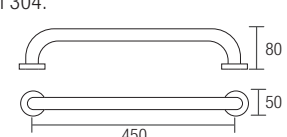
Select from a range of various depths, rectangle, corner and semi-circular wire basket designs that display strength and creative excellence. Constructed of heavy chrome plated brass. All baskets have innovative concealed fixings.

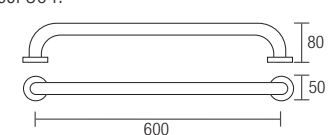
	Code	Finish	Features
WB 001 - RECTANGULAR BASKET - LARGE			
	WB 001 C	Chrome	
	WB 001 CG	Chrome/Gold	
WB 002 - RECTANGULAR BASKET - MEDIUM			
	WB 002 C	Chrome	
	WB 002 CG	Chrome/Gold	
WB 003 - RECTANGULAR BASKET - SMALL			
	WB 003 C	Chrome	
	WB 003 CG	Chrome/Gold	
WB 004 - OPEN FRONT RECTANGULAR BASKET - MEDIUM			
	WB 004 C	Chrome	
	WB 004 CG	Chrome/Gold	
WB 005 - OPEN FRONT RECTANGULAR BASKET - SMALL			
	WB 005 C	Chrome	
	WB 005 CG	Chrome/Gold	
WB 006 - CORNER BASKET WITH HOOK			
	WB 006 C	Chrome	
	WB 006 CG	Chrome/Gold	
WB 007 - CORNER BASKET - LARGE			
	WB 007 C	Chrome	
	WB 007 CG	Chrome/Gold	
WB 008 - CORNER BASKET - MEDIUM			
	WB 008 C	Chrome	
	WB 008 CG	Chrome/Gold	
WB 009 - CORNER BASKET - SMALL			
	WB 009 C	Chrome	
	WB 009 CG	Chrome/Gold	
WB 010 - SEMI-CIRCULAR BASKET - LARGE			
	WB 010 C	Chrome	
	WB 010 CG	Chrome/Gold	

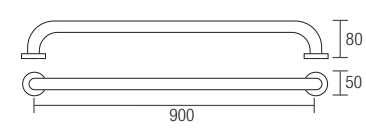
BATHROOM RAILS - COMFORT COLLECTION

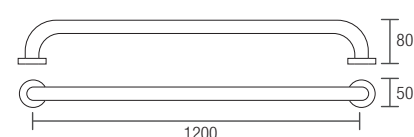
All purpose 25 mm rail for kitchen and bathroom support use. Not specifically designed for people with disabilities. Fabricated from 304 stainless steel with 50 mm triple screw wall mount plates and screw on end caps.

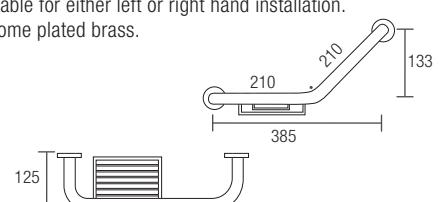
Coloured rails are only made to order and are non-returnable.

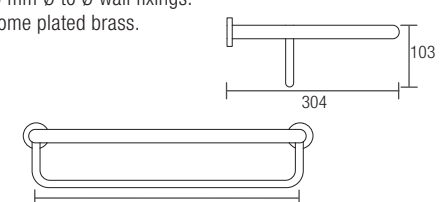
	Code	Finish	Features
300 mm - 25 mm COMFORT RAIL			
	CR 300 PS	Polish Supreme™	300 mm Ø to Ø wall fixings. Stainless steel 304.
	CR 300 FC	Full Colour	
	CR 300 ACG	Colour/Gold	
	CR 300 G	Gold	
			
450 mm - 25 mm COMFORT RAIL			
	CR 450 PS	Polish Supreme™	450 mm Ø to Ø wall fixings. Stainless steel 304.
	CR 450 FC	Full Colour	
	CR 450 ACG	Colour/Gold	
	CR 450 G	Gold	
			
600 mm - 25 mm COMFORT RAIL			
	CR 600 PS	Polish Supreme™	600 mm Ø to Ø wall fixings. Stainless steel 304.
	CR 600 FC	Full Colour	
	CR 600 ACG	Colour/Gold	
	CR 600 G	Gold	
			
900 mm - 25 mm COMFORT RAIL			
	CR 900 PS	Polish Supreme™	900 mm Ø to Ø wall fixings. Stainless steel 304.
	CR 900 FC	Full Colour	
	CR 900 ACG	Colour/Gold	
	CR 900 G	Gold	
			
1200 mm - 25 mm COMFORT RAIL			
	CR 1200 PS	Polish Supreme™	1200 mm Ø to Ø wall fixings. Stainless steel 304.
	CR 1200 FC	Full Colour	
	CR 1200 ACG	Colour/Gold	
	CR 1200 G	Gold	
			
210 mm x 210 mm - 25 mm RAMPED COMFORT RAIL WITH SOAP BASKET			
	CR 036 C	Chrome	385 mm Ø to Ø wall fixings with 133 mm rise. Suitable for either left or right hand installation. Chrome plated brass.
			
600 mm - 25 mm BATH TOWEL SHELF			
	CR 022 C	Chrome	600 mm Ø to Ø wall fixings. Chrome plated brass.
			



Shower Systems for Healthcare Applications

Shower systems for healthcare applications usually require the installation of height adjustable handheld showers to cater for the able bodied as well as those who need to use a shower chair to clean themselves. There must also be provisions for assistance where someone is incapable of performing the cleaning task unaided. Handheld showers for these applications should be light weight, capable of withstanding dropping, easily held in soapy hands and have a soft spray pattern as to not irritate sensitive skin. Hoses should have a smooth surface to allow thorough cleaning as well. Con-Serv's HOSFAB® handheld showers and hoses meet these requirements.

Where requested a handpiece that has an additional pulsating action to relax or to provide aqua-massage hydrotherapy treatment to relieve pain or promote healing can be supplied.

Handheld showers for professional use are supplied with licenced dual check valves to stop contamination of the water system. As with all Con-Serv handheld showers, the valves are located with the flow control at the wall outlet elbow.

Careful selection from the HOSFAB® range will result in a shower support system that has been designed to fit many applications and give years of reliable service.



Select from our four ranges of HOSFAB® shower systems for healthcare applications

PWD HOSFAB®	12 - 13
Commercial HOSFAB®	14 - 17
Standard HOSFAB®	18 - 21
Premium HOSFAB®	22 - 25





REFERENCE GUIDE TO COMMERCIAL HS 018 & PWD HOSFAB® KITS



HS 018 HOSFAB® KITS

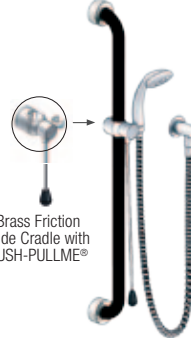
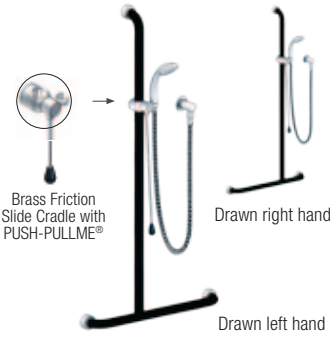
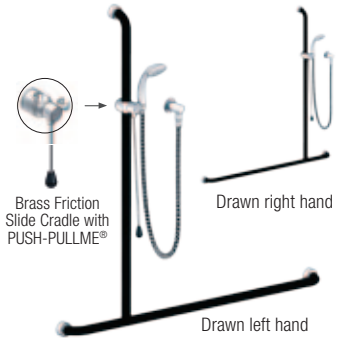

 <p>Features and benefits page 15</p> <p>HS 018 KIT 1</p>	 <p>Brass Friction Slide Cradle</p> <p>Features and benefits page 15</p> <p>HS 018 KIT 3</p>	 <p>Brass Friction Slide Cradle</p> <p>Drawn right hand</p> <p>Drawn left hand</p> <p>Features and benefits page 15</p> <p>HS 018 KIT 5</p>	 <p>ABS Glide Slide Cradle</p> <p>Features and benefits page 15</p> <p>HS 018 KIT 6</p>
 <p>Features and benefits page 15</p> <p>HS 018 KIT 7</p>	 <p>ABS Glide Slide Cradle</p> <p>Features and benefits page 16</p> <p>HS 018 KIT 9</p>	 <p>Features and benefits page 16</p> <p>HS 018 KIT 12</p>	 <p>ABS Glide Slide Cradle</p> <p>Drawn right hand</p> <p>Drawn left hand</p> <p>Features and benefits page 16</p> <p>HS 018 KIT 13</p>
 <p>ABS Glide Slide Cradle</p> <p>Drawn right hand</p> <p>Drawn left hand</p> <p>Features and benefits page 16</p> <p>HS 018 KIT 14</p>	 <p>ABS Glide Slide Cradle</p> <p>Drawn right hand</p> <p>Drawn left hand</p> <p>Drawn centre fix</p> <p>Features and benefits page 17</p> <p>HS 018 KIT 16</p>	 <p>Brass Friction Slide Cradle</p> <p>Drawn right hand</p> <p>Drawn left hand</p> <p>Drawn centre fix</p> <p>Features and benefits page 17</p> <p>HS 018 KIT 20</p>	 <p>Brass Friction Slide Cradle</p> <p>Drawn right hand</p> <p>Drawn left hand</p> <p>Features and benefits page 17</p> <p>HS 018 KIT 21</p>

PWD HOSFAB® KITS

 <p>Features and benefits page 17</p> <p>HS 018 KIT 22</p>	 <p>Brass Friction Slide Cradle with PUSH-PULLME®</p> <p>Features and benefits page 13</p> <p>ID 018-3</p>	 <p>Brass Friction Slide Cradle with PUSH-PULLME®</p> <p>Drawn right hand</p> <p>Drawn left hand</p> <p>Features and benefits page 13</p> <p>ID 018-20</p>	 <p>Brass Friction Slide Cradle with PUSH-PULLME®</p> <p>Drawn right hand</p> <p>Drawn left hand</p> <p>Features and benefits page 13</p> <p>ID 018-21</p>
---	---	--	---



PWD HOSFAB® - INDEPENDENT ACCESSIBLE HEALTHCARE SHOWER KIT FOR SEATED USERS

1000 mm Satin Supreme 304 independent accessible grab rail/shower kit, assembled with 50 mm  HYGIENIC SEAL® healthsafe flange covers and **Brass Friction Slide Cradle** with "PUSH-PULLME®" handset height adjustment rod for seated users. The  HYGIENIC SEAL® healthsafe flange with Thermoplastic Elastomer (TPE) fitted seal prevents grime such as soap scum, body fluids, ointments and aqueous based fluids accumulating behind the flange cover and creating possible serious health issues. Putting health and hygiene foremost, the grab rails comply with clause 17 of AS 1428.1-2009 for

Design and Construction.



MODEL SHOWN ID 018-3 INDEPENDENT ACCESSIBLE HOSFAB®

INDICATIVE IMAGE ONLY
(Refer to page 54, figure 48 for recommended positioning)

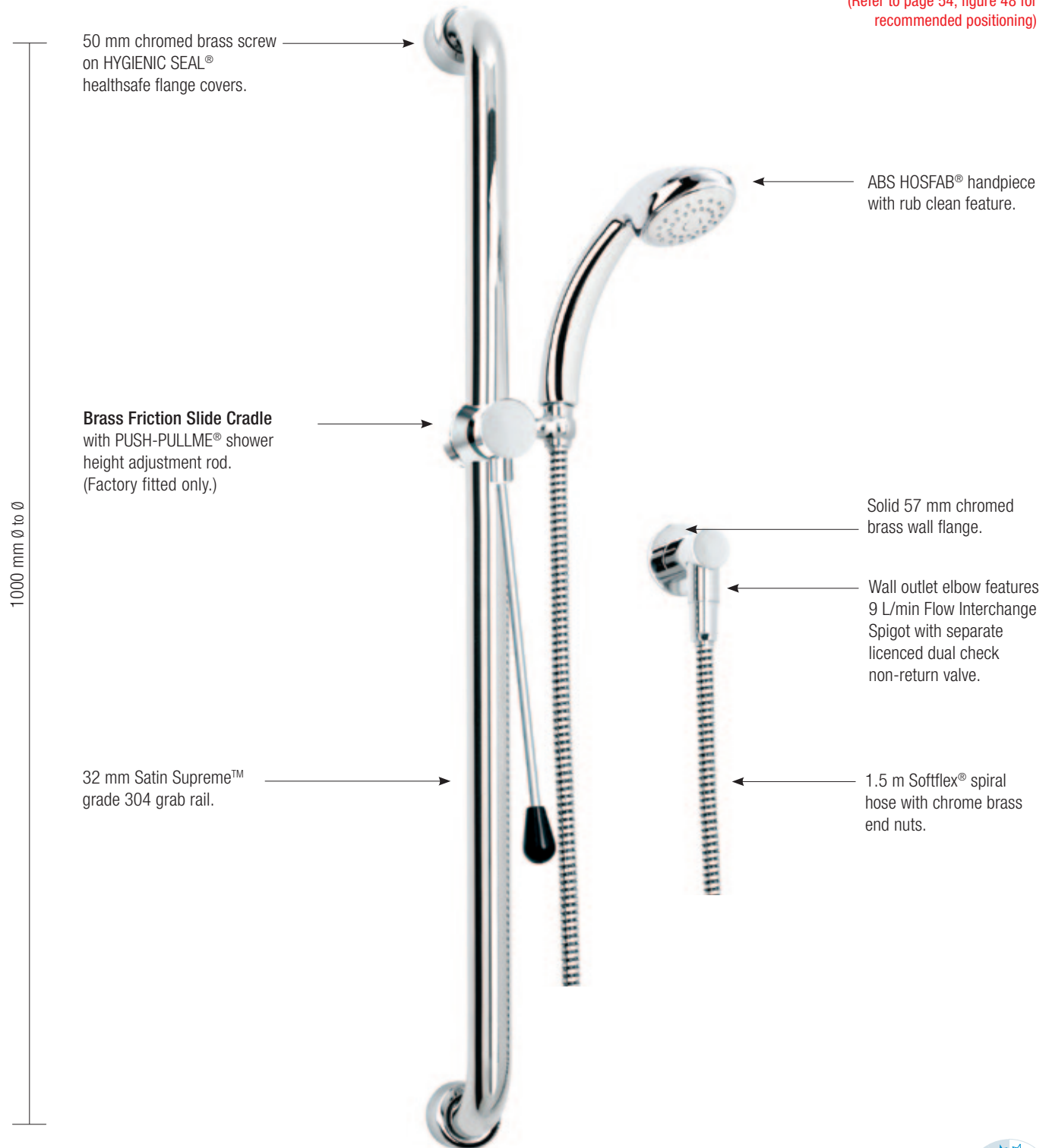

Stainless steel screws and wall plugs provided.

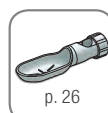



PWD HOSFAB® - HEALTHCARE KIT WITH PUSH-PULLME® FOR SEATED USERS

Independent accessible healthcare kits are made from the highest quality tested products and materials and feature dual check facilities as per AS/NZ 3500. The grab rails are fabricated from 304 stainless steel and assembled with 50 mm chromed brass screw on HYGIENIC SEAL® flange covers with Thermoplastic Elastomer (TPE) fitted seals and comply with clause 17 of AS 1428.1-2009 for Design and Construction.



AS 1428.1 - 2009 15.5.6 Shower Head

An adjustable shower head holder shall be provided to support the shower head and shall allow the graspable portion of the shower head to be positioned at various angles and heights and also allow the graspable portion of the shower head to be located at heights between 1000 mm and 1800 mm above the plane of the finished floor and allow access and adjustment from a seated position.

The above clause only applies to bathrooms specifically designed for People with Disabilities (PWD) in public buildings, factories, hotels, motels and designated PWD bathrooms in hospitals, homes for the elderly and nursing homes.

	Code	Finish	Features
ID 018-3 INDEPENDENT HOSFAB® - PWD			
	ID 018-03 CW	Chrome/White 1.5 m hose	1000 mm Satin Supreme™ grab rail, assembled with HYGIENIC SEAL® healthsafe flange covers and Brass Friction Slide Cradle with PUSH-PULLME® shower height adjustment rod for seated persons. Also includes a strong and stylish ABS handpiece, PVC reinforced Soffflex® spiral hose and wall outlet elbow which features 9 L/min Flow Interchange Spigot and separate licenced dual check/non return valves to prevent back siphonage. 3 Star - 9 L/min rated as per WELS licence number 0046. Complies with requirements for a 2 walled shower enclosure when installed with HS 700 as per 1428.1-2009.
	ID 018-03 C	Chrome 1.5 m hose	
	ID 018-03 CW2	Chrome/White 2 m hose	
	ID 018-03 C2	Chrome 2 m hose	

INDICATIVE IMAGE ONLY
(Refer to page 54, figure 48 for recommended positioning)

	Code	Finish	Features
ID 018-20 INDEPENDENT HOSFAB® - PWD Please specify left or right hand			
	ID 018-20 CW	Chrome/White 1.5 m hose	TO SUIT ACCESSIBLE SHOWER RECESS. 700 mm x 1100 mm Satin Supreme™ inverted "T" handed grab rail, assembled with HYGIENIC SEAL® healthsafe flange covers and Brass Friction Slide Cradle with PUSH-PULLME shower height adjustment rod for seated persons. Also includes a strong and stylish ABS handpiece, PVC reinforced Soffflex® spiral hose and wall outlet elbow which features 9 L/min Flow Interchange Spigot and separate licenced dual check/non return valves to prevent back siphonage. 3 Star - 9 L/min rated as per WELS licence number 0046. Complies with requirements for a 2 walled shower enclosure as per 1428.1-2009.
	ID 018-20 C	Chrome 1.5 m hose	
	ID 018-20 CW2	Chrome/White 2 m hose	
	ID 018-20 C2	Chrome 2 m hose	

INDICATIVE IMAGE ONLY
(Refer to page 54, figure 48 for recommended positioning)

	Code	Finish	Features
ID 018-21 INDEPENDENT HOSFAB® - PWD Please specify left or right hand			
	ID 018-21 CW	Chrome/White 1.5 m hose	TO SUIT COMBINED ACCESSIBLE SANITARY COMPARTMENT. 1170 mm x 1100 mm Satin Supreme™ inverted "T" handed grab rail, assembled with HYGIENIC SEAL® healthsafe flange covers and Brass Friction Slide Cradle with PUSH-PULLME shower height adjustment rod for seated persons. Also includes a strong and stylish ABS handpiece, PVC reinforced Soffflex® spiral hose and wall outlet elbow which features 9 L/min Flow Interchange Spigot and separate licenced dual check/non return valves to prevent back siphonage. 3 Star - 9 L/min rated as per WELS licence number 0046. Complies with requirements for a 2 walled shower enclosure as per 1428.1-2009.
	ID 018-21 C	Chrome 1.5 m hose	
	ID 018-21 CW2	Chrome/White 2 m hose	
	ID 018-21 C2	Chrome 2 m hose	

INDICATIVE IMAGE ONLY
(Refer to page 56, figure 50 for recommended positioning)



COMMERCIAL HOSFAB® - HEALTHCARE SHOWER KIT WITH BRASS FRICTION SLIDE CRADLE AND ABS SLIDE CRADLE OPTIONS

900 mm Satin Supreme 304 grab rail/shower kit, assembled with 50 mm HYGIENIC SEAL® healthsafe flange covers and **BRASS FRICTION SLIDE CRADLE** (ABS OPTIONAL). The HYGIENIC SEAL® healthsafe flange with Thermoplastic Elastomer (TPE) fitted seal prevents grime such as soap scum, body fluids, ointments and aqueous based fluids accumulating behind the flange cover and creating possible serious health issues. Putting health and hygiene foremost, the grab rails comply with clause 17 of AS 1428.1-2009 for Design and Construction.

MODEL SHOWN HS 018-3 COMMERCIAL HOSFAB® KIT

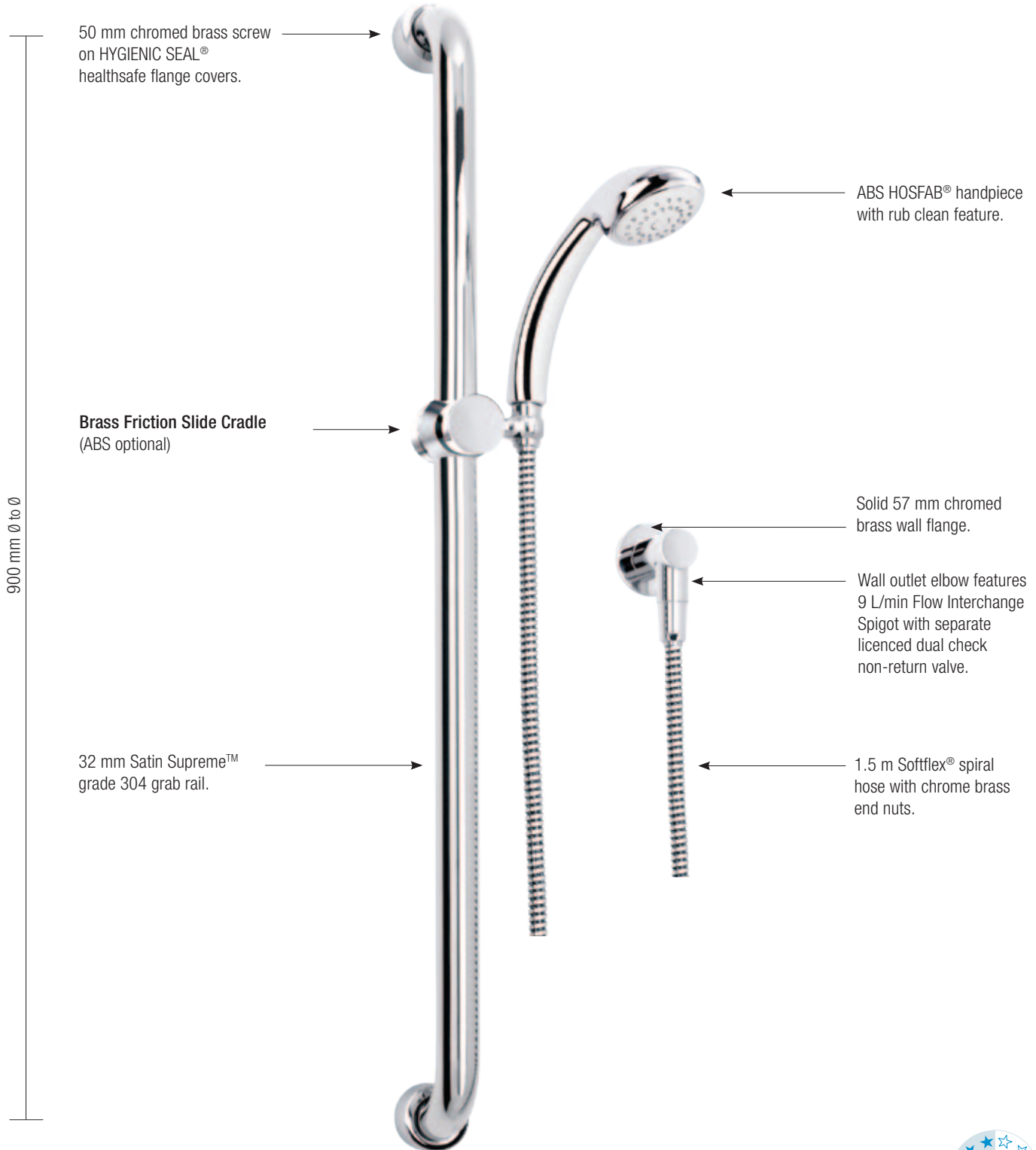

Stainless steel screws and wall plugs provided.



Hygienic seal



Optional extra: SD 032 Soap Dish









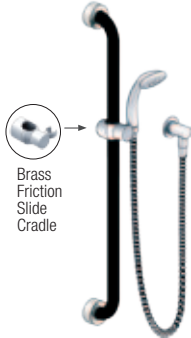

COMMERCIAL HOSFAB® - OPTIONS

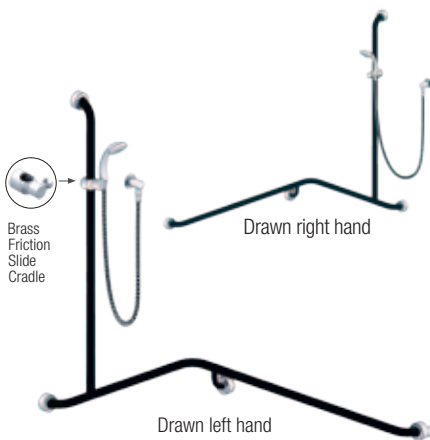
Commercial healthcare shower support options, made from the highest quality tested products and materials and feature dual check facilities as per AS/NZ 3500. Designed for installations in hospitals, homes for the elderly, nursing homes, private and public facilities. Grab rail kits comply with clause 17 of 1428.1-2009 for Design and Construction.

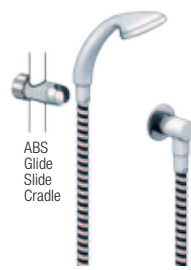

	Code	Finish	Features
HS 018 KIT 1			
	HS 018-01 CW	Chrome/White 1.5 m hose and handpiece	Handheld shower kit with stylish ABS handpiece, PVC 1.5 m reinforced Softflex® spiral hose and wall outlet elbow bracket which features 9 L/min Flow Interchange Spigot and separate licenced dual check/non-return valve to prevent back siphonage. 3 Star - 9 L/m rated as per WELS licence number 0046.
	HS 018-01 C	Chrome 1.5 m hose and handpiece	
HS 018 KIT 3			
 <p>Brass Friction Slide Cradle</p>	HS 018-03 CW	Chrome/White 1.5 m hose and handpiece	900 mm Satin Supreme™ grade 304 grab rail, assembled with HYGIENIC SEAL® healthsafe flange covers with Brass Friction Slide Cradle fastened and tensioned to the grab rail for handset support and movement. Also includes a strong and stylish ABS handpiece, PVC 1.5 m reinforced Softflex® spiral hose and wall outlet elbow which features 9 L/min Flow Interchange Spigot and separate licenced dual check/non return valves to prevent back siphonage. 3 Star - 9 L/min rated as per WELS licence number 0046. Complies with requirements for 2 walled shower enclosure when installed with HS 700 as per AS 1428 - 2009.
	HS 018-03 C	Chrome 1.5 m hose and handpiece	
	HS 018-03 CW2	Chrome/White 2 m hose and handpiece	
	HS 018-03 C2	Chrome 2 m hose and handpiece	
			 
HS 018 KIT 5			
Please specify left or right hand			
 <p>Brass Friction Slide Cradle</p> <p>Drawn right hand</p> <p>Drawn left hand</p>	HS 018-05 CW	Chrome/White 1.5 m hose and handpiece	760 mm x 1000 mm x 1100 mm Satin Supreme™ grade 304 grab rail, assembled with HYGIENIC SEAL® healthsafe flange covers with Brass Friction Slide Cradle fastened and tensioned to the grab rail for handset support and movement. Also includes a strong and stylish ABS handpiece, PVC 1.5 m reinforced Softflex® spiral hose and wall outlet elbow which features 9 L/min Flow Interchange Spigot and separate licenced dual check/non return valves to prevent back siphonage. 3 Star - 9 L/min rated as per WELS licence number 0046.
	HS 018-05 C	Chrome 1.5 m hose and handpiece	
	HS 018-05 CW2	Chrome/White 2 m hose and handpiece	
	HS 018-05 C2	Chrome 2 m hose and handpiece	
			
HS 018 KIT 6			
 <p>ABS Glide Slide Cradle</p>	HS 018-06 CW	Chrome/White 1.5 m hose and handpiece	Handheld shower kit to suit 32 mm grab rail refurbishment. Kit includes ABS Glide Slide Cradle to be fastened and tensioned to the grab rail for handset support and movement. Also includes a stylish ABS handpiece, PVC 1.5 m reinforced Softflex® spiral hose and wall outlet elbow which features 9 L/min Flow Interchange Spigot and separate licenced dual check/non-return to prevent back siphonage. 3 Star - 9 L/m rated as per WELS licence number 0046. NO GRAB RAIL SUPPLIED
	HS 018-06 C	Chrome 1.5 m hose and handpiece	
	HS 018-06 CW2	Chrome/White 2 m hose and handpiece	
	HS 018-06 C2	Chrome 2 m hose and handpiece	
HS 018 KIT 7			
	HS 018-07 CW	Chrome/White 1.5 m hose and handpiece	Psychiatric care handshower kit to suit 32 mm grab rail refurbishment with quick release coupling and dry break stop valve. Kit also includes the HOSFAB® handpiece, PVC high pressure reinforced Black Silver Braid spiral hose and wall outlet elbow which features 9L/min Flow Interchange Spigot and separate licenced dual check/non return to prevent back siphonage. 3 Star - 9 L/m rated as per WELS licence number 0046. NO GRAB RAIL SUPPLIED
	HS 018-07 C	Chrome 1.5 m hose and handpiece	
	HS 018-07 CW2	Chrome/White 2 m hose and handpiece	
	HS 018-07 C2	Chrome 2 m hose and handpiece	



COMMERCIAL HOSFAB® - OPTIONS

Commercial healthcare shower support options, made from the highest quality tested products and materials and feature dual check facilities as per AS/NZ 3500. Designed for installations in hospitals, homes for the elderly, nursing homes, private and public facilities. Grab rail kits comply with clause 17 of 1428.1-2009 for Design and Construction.









	Code	Finish	Features
HS 018 KIT 9			
<p>ABS Glide Slide Cradle</p>	HS 018-09 CW	Chrome/White 1.5 m hose and handpiece	<p>900 mm Satin Supreme™ grade 304 grab rail, assembled HYGIENIC SEAL® healthsafe flange covers with ABS Glide Slide Cradle fastened and tensioned to the grab rail for handset support and movement. Also includes a strong and stylish ABS handpiece, PVC reinforced Softflex® spiral hose and wall outlet elbow which features 9 L/min Flow Interchange spigot and separate licenced dual check/non return valves to prevent back siphonage.</p> <p>3 Star - 9 L/min rated as per WELS licence number 0046.</p> <p>Complies with requirements for a 2 walled shower enclosure when installed with HS 700 SS as per AS 1428.1 -2009.</p>
	HS 018-09 C	Chrome 1.5 m hose and handpiece	
	HS 018-09 CW2	Chrome/White 2 m hose and handpiece	
	HS 018-09 C2	Chrome 2 m hose and handpiece	
HS 018 KIT 12			
	HS 018-12 CW	Chrome/White 1.5 m hose and handpiece	<p>Handheld shower kit to suit 32 mm grab rail refurbishment. Also includes a stylish ABS handpiece, PVC 1.5 m reinforced Softflex® spiral hose and wall outlet elbow which features 9 L/min Flow Interchange Spigot and separate licenced dual check/non-return valve to prevent back siphonage.</p> <p>3 Star - 9 L/min rated as per WELS licence number 0046.</p> <p>HANDHELD SHOWER KIT FOR ALL GRAB RAIL MODELS.</p>
	HS 018-12 C	Chrome 1.5 m hose and handpiece	
	HS 018-12 CW2	Chrome/White 2 m hose and handpiece	
	HS 018-12 C2	Chrome 2 m hose and handpiece	
HS 018 KIT 13			
Please specify left or right hand			
<p>Drawn right hand</p> <p>Drawn left hand</p>	HS 018-13 CW	Chrome/White 1.5 m hose and handpiece	<p>760 mm x 1000 mm x 1100 mm Satin Supreme™ grade 304 grab rail assembled with HYGIENIC SEAL® healthsafe flange covers with ABS Glide Slide Cradle fastened and tensioned to the grab rail for handset support and movement. Also includes a strong and stylish ABS handpiece, PVC reinforced Softflex® spiral hose and wall outlet elbow which features 9 L/min Flow Interchange Spigot and separate licenced dual check/non return valves to prevent back siphonage.</p> <p>3 Star - 9 L/min rated as per WELS licence number 0046.</p>
	HS 018-13 C	Chrome 1.5 m hose and handpiece	
	HS 018-13 CW2	Chrome/White 2 m hose and handpiece	
	HS 018-13 C2	Chrome 2 m hose and handpiece	
HS 018 KIT 14			
Please specify left or right hand			
<p>Drawn left hand</p> <p>Drawn right hand</p>	HS 018-14 CW	Chrome/White 1.5 m hose and handpiece	<p>400 mm x 1100 mm Satin Supreme™ grade 304 "L" shape grab rail assembled with HYGIENIC SEAL® healthsafe flange covers with ABS Glide Slide Cradle fastened and tensioned to the grab rail for handset support and movement. Also includes a strong and stylish ABS handpiece, PVC reinforced Softflex® spiral hose and wall outlet elbow which features 9 L/min Flow Interchange Spigot and separate licenced dual check/non return valves to prevent back siphonage.</p> <p>3 Star - 9 L/min rated as per WELS licence number 0046.</p> <p>MADE TO ORDER - NON RETURNABLE</p>
	HS 018-14 C	Chrome 1.5 m hose and handpiece	
	HS 018-14 CW2	Chrome/White 2 m hose and handpiece	
	HS 018-14 C2	Chrome 2 m hose and handpiece	



COMMERCIAL HOSFAB® - OPTIONS

Commercial healthcare shower support options, made from the highest quality tested products and materials and feature dual check facilities as per AS/NZ 3500. Designed for installations in hospitals, homes for the elderly, nursing homes, private and public facilities. Only left and right handed kits comply with dimensional requirements of AS 1428.1-2009 but all comply with clause 17 of 1428.1-2009 for Design and Construction.



Code	Finish	Features
HS 018 KIT 16 Please specify left or right or centre fix		
	HS 018-16 CW	Chrome/White 1.5 m hose and handpiece
	HS 018-16 C	Chrome 1.5 m hose and handpiece
	HS 018-16 CW2	Chrome/White 2 m hose and handpiece
	HS 018-16 C2	Chrome 2 m hose and handpiece
		<p>700 mm x 1100 mm Satin Supreme™ grade 304 inverted "T" grab rail, assembled with HYGIENIC SEAL® healthsafe flange covers and ABS GLIDE SLIDE CRADLE fastened and tensioned to the grab rail for handset support and movement. Also includes a strong and stylish handpiece, PVC reinforced Softflex® spiral hose and wall outlet elbow which features 9 L/min Flow Interchange Spigot and separate licenced dual check/non return valves to prevent back siphonage.</p> <p>3 Star - 9 L/min rated as per WELS licence number 0046. Complies with requirements for a 2 walled shower enclosure as per AS 1428.1-2009.</p> <p>Left and right hand models only comply to AS 1428.1</p>  
HS 018 KIT 20 Please specify left or right or centre fix		
	HS 018-20 CW	Chrome/White 1.5 m hose and handpiece
	HS 018-20 C	Chrome 1.5 m hose and handpiece
	HS 018-20 CW2	Chrome/White 2 m hose and handpiece
	HS 018-20 C2	Chrome 2 m hose and handpiece
		<p>700 mm x 1100 mm Satin Supreme™ grade 304 inverted "T" grab rail, assembled with HYGIENIC SEAL® healthsafe flange covers and BRASS FRICTION SLIDE CRADLE fastened and tensioned to the grab rail for handset support and movement. Also includes a strong and stylish handpiece, PVC reinforced Softflex® spiral hose and wall outlet elbow which features 9 L/min Flow Interchange Spigot and separate licenced dual check/non return valves to prevent back siphonage.</p> <p>3 Star - 9 L/min rated as per WELS licence number 0046.</p> <p>Left and right hand models only comply to AS 1428.1</p>  
HS 018 KIT 21 Please specify left or right hand		
	HS 018-21 CW	Chrome/White 1.5 m hose and handpiece
	HS 018-21 C	Chrome 1.5 m hose and handpiece
	HS 018-21 CW2	Chrome/White 2 m hose and handpiece
	HS 018-21 C2	Chrome 2 m hose and handpiece
		<p>1170 mm x 1100 mm Satin Supreme™ grade 304 inverted "T" grab rail, assembled with HYGIENIC SEAL® healthsafe flange covers and BRASS FRICTION SLIDE CRADLE fastened and tensioned to the grab rail for handset support and movement. Also includes a strong and stylish handpiece, PVC reinforced Softflex® spiral hose and wall outlet elbow which features 9 L/min Flow Interchange Spigot and separate licenced dual check/non return valves to prevent back siphonage.</p> <p>3 Star - 9 L/min rated as per WELS licence number 0046. Complies with requirements for a 2 walled shower enclosure as per AS 1428.1-2009.</p>  
HS 018 KIT 22 A.B.C. WASH DOWN KIT		
	HS 018-22 CB	Chrome/Black Silver braid 900 mm hose
	HS 018-22 CB1	Chrome/Black Silver braid 1.5 mm mm hose
	HS 018-22 CB2	Chrome/Black Silver braid 2 mm mm hose
	HS 018-22 CB3	Chrome/Black Silver braid 3 m hose
		<p>A - Automobiles, B - Boats, C - Childcare Centres. The Colt trigger wash down gun with on/off lock function adjusts to variable spray patterns. Supplied with PVC heavy duty reinforced smooth hose, right angled wall mount gun nozzle cradle and wall outlet elbow which features 9 L/min Flow Interchange Spigot and separate licenced dual check/non-return valve to prevent back siphonage.</p> <p>PLEASE NOTE: The colt has a maximum operating pressure of 550 kPa (80PSI) with maximum operating temperature of 55°C.</p> <p>NOT TO BE USED AS LINE END STOP CONTROL.</p> 



STANDARD HOSFAB® - HEALTHCARE SHOWER KIT WITH ABS GLIDE SLIDE CRADLE

900 mm Polished Supreme 304 grab rail/shower kit, assembled with 50 mm **HYGIENIC SEAL®** healthsafe flange covers and ABS GLIDE SLIDE CRADLE fastened and tensioned to the grab rail for handset support and movement. The **HYGIENIC SEAL®** healthsafe flange covers with Thermoplastic Elastomer (TPE) fitted seal prevent grime such as soap scum, body fluids, ointments and aqueous based fluids accumulating behind the grab rail flange and creating possible serious health issues. Putting health and hygiene foremost, the grab rails comply with clause 17 of AS 1428.1-2009 for Design and Construction.



MODEL SHOWN GS 900 F - STANDARD HOSFAB® KIT



Stainless steel screws and wall plugs provided.



Hygienic seal

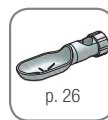

p. 26

Optional extra: SD 032 Soap Dish



WaterMark
AS/NZS 3662
WMKT 21147



AS 1428.1



DIMENSIONAL COMPLIANT



Lic. no. 0046







STANDARD HOSFAB® - SELECTIONS

900 mm WITH ABS GLIDE SLIDE CRADLE

Home and healthcare shower selections with 900 mm Polished Supreme grade 304 grab rail, assembled with the highest quality tested products and materials and feature dual check facilities as per AS/NZ 3500. Suits installations in hospitals, homes for the elderly, nursing homes, private and public facilities. Selections comply with clause 17 of AS 1428.1-2009 for Design and Construction.



	Code	Finish	Features
GS 900 C CHAMPAGNE PULSATOR			
	GS 900 C-C	Polish Supreme™	<p>900 mm Polished Supreme™ grade 304 grab rail, assembled with HYGIENIC SEAL® healthsafe flange covers with ABS Glide Slide Cradle fastened and tensioned to the grab rail for handset support and movement. Kit includes ABS Champagne Pulsator handpiece, PVC 1.5 m reinforced Soffflex® spiral hose and wall outlet elbow which features 9 L/min Flow Interchange Spigot and separate licenced dual check/non-return valves to prevent back siphonage.</p> <p>3 Star - 9 L/m rated as per WELS licence number 0046.</p> <p>Complies with requirements for a 2 walled shower enclosure when installed with HS 700 PS as per AS 1428.1-2009.</p>
	GS 900 C-WTC	White/Chrome	
	GS 900 C-WTG	White/Gold	
	GS 900 C-SC	Satin Completely	
	GS 900 C-CG	Chrome/Gold	
	GS 900 C-G	Gold	
			 
GS 900 P PRINCESS			
	GS 900 P-C	Polish Supreme™	<p>900 mm Polished Supreme™ grade 304 grab rail, assembled with HYGIENIC SEAL® healthsafe flange covers with ABS Glide Slide Cradle fastened and tensioned to the grab rail for handset support and movement. Kit includes ABS Princess handpiece, PVC 1.5 m reinforced Soffflex® spiral hose and wall outlet elbow which features 9 L/min Flow Interchange Spigot and separate licenced dual check/non-return valves to prevent back siphonage.</p> <p>3 Star - 9 L/m rated as per WELS licence number 0046.</p> <p>Complies with requirements for a 2 walled shower enclosure when installed with HS 700 PS as per AS 1428.1-2009.</p>
	GS 900 P-ACC	Colour/Chrome	
	GS 900 P-ACG	Colour/Gold	
	GS 900 P-CG	Chrome/Gold	
	GS 900 P-G	Gold	
			 
GS 900 F HOSFAB			
	GS 900 F-C	Polish Supreme™	<p>900 mm Polished Supreme™ grade 304 grab rail, assembled with HYGIENIC SEAL® healthsafe flange covers with ABS Glide Slide Cradle fastened and tensioned to the grab rail for handset support and movement. Kit includes ABS Hosfab handpiece, PVC 1.5 m reinforced Soffflex® spiral hose and wall outlet elbow which features 9 L/min Flow Interchange Spigot and separate licenced dual check/non-return valves to prevent back siphonage.</p> <p>3 Star - 9 L/m rated as per WELS licence number 0046.</p> <p>Complies with requirements for a 2 walled shower enclosure when installed with HS 700 PS as per AS 1428.1-2009.</p>
	GS 900 F-WTC	White/Chrome	
			 











STANDARD HOSFAB® - SELECTIONS

700 mm x 1100 mm WITH ABS GLIDE SLIDE CRADLE

Home and healthcare shower selections with 700 mm x 1100 mm Polished Supreme grade 304 inverted "T" grab rail, assembled with the highest quality tested products and materials and feature dual check facilities as per AS/NZ 3500.

Suits installations in hospitals, homes for the elderly, nursing homes, private and public facilities. Only left and right handed kits comply with dimensional requirements of AS 1428.1-2009 but all comply with clause 17 of 1428.1-2009 for Design and Construction.



	Code	Finish	Features
GS 071 C CHAMPAGNE PULSATOR Please specify left or right or centre fix			
 Drawn left hand  Drawn right hand  Drawn centre fix	GS 071 C-C	Polish Supreme™	700 mm x 1100 mm Polished Supreme™ inverted "T" grab rail, assembled with HYGIENIC SEAL® healthsafe flange covers and ABS Glide Slide Cradle fastened and tensioned to the grab rail for handset support and movement. Kit includes ABS Champagne Pulsator handpiece, PVC 1.5 m reinforced Softflex® spiral hose and wall outlet elbow which features 9 L/min Flow Interchange Spigot and separate licenced dual check/non return valves to prevent back siphonage. 3 Star - 9 L/min rated as per WELS licence number 0046. Left and right hand models only comply to AS 1428.1
	GS 071 C-WTC	White/Chrome	
	GS 071 C-WTG	White/Gold	
	GS 071 C-CG	Chrome/Gold	
GS 071 P PRINCESS Please specify left or right or centre fix			
 Drawn left hand  Drawn right hand  Drawn centre fix	GS 071 P-C	Polish Supreme™	700 mm x 1100 mm Polished Supreme™ inverted "T" grab rail, assembled with HYGIENIC SEAL® healthsafe flange covers and ABS Glide Slide Cradle fastened and tensioned to the grab rail for handset support and movement. Kit includes ABS Princess handpiece, PVC 1.5 m reinforced Softflex® spiral hose and wall outlet elbow which features 9 L/min Flow Interchange Spigot and separate licenced dual check/non return valves to prevent back siphonage. 3 Star - 9 L/min rated as per WELS licence number 0046. Left and right hand models only comply to AS 1428.1
	GS 071 P-ACC	Colour/Chrome	
	GS 071 P-ACG	Colour/Gold	
	GS 071 P-CG	Chrome/Gold	
GS 071 F HOSFAB Please specify left or right or centre fix			
 Drawn left hand  Drawn right hand  Drawn centre fix	GS 071 F-C	Polish Supreme™	700 mm x 1100 mm Polished Supreme™ inverted "T" grab rail, assembled with HYGIENIC SEAL® healthsafe flange covers and ABS Glide Slide Cradle fastened and tensioned to the grab rail for handset support and movement. Kit includes ABS Hosfab® handpiece, PVC 1.5 m reinforced Softflex® spiral hose and wall outlet elbow which features 9 L/min Flow Interchange Spigot and separate licenced dual check/non return valves to prevent back siphonage. 3 Star - 9 L/min rated as per WELS licence number 0046. Left and right hand models only comply to AS 1428.1
	GS 071 F-WTC	White/Chrome	

















STANDARD HOSFAB® - SELECTIONS

1170 mm x 1100 mm WITH ABS GLIDE SLIDE CRADLE

Home and healthcare shower selections with 1170 mm x 1100 mm Polished Supreme grade 304 inverted "T" grab rail, assembled with the highest quality tested products and materials and feature dual check facilities as per AS/NZ 3500. Suits installations in hospitals, homes for the elderly, nursing homes, private and public facilities. Complies with dimensional requirements of 1428.1-2009 and Clause 17 of 1428.1-2009 for Design and Construction.



	Code	Finish	Features
GS 191 C CHAMPAGNE PULSATOR Please specify left or right hand			
 <p>Drawn left hand</p>  <p>Drawn right hand</p>	GS 191 C-C	Polish Supreme™	1170 mm x 1100 mm Polished Supreme™ inverted "T" grab rail, assembled with HYGIENIC SEAL® healthsafe flange covers and ABS Glide Slide Cradle fastened and tensioned to the grab rail for handset support and movement. Kit includes ABS Champagne Pulsator handpiece, PVC 1.5 m reinforced Softflex® spiral hose and wall outlet elbow which features 9 L/min Flow Interchange Spigot and separate licenced dual check/non return valves to prevent back siphonage.
	GS 191 C-WTC	White/Chrome	
	GS 191 C-WTG	White/Gold	
	GS 191 C-CG	Chrome/Gold	
 			
GS 191 P PRINCESS Please specify left or right hand			
 <p>Drawn left hand</p>  <p>Drawn right hand</p>	GS 191 P-C	Polish Supreme™	1170 mm x 1100 mm Polished Supreme™ inverted "T" grab rail, assembled with HYGIENIC SEAL® healthsafe flange covers and ABS Glide Slide Cradle fastened and tensioned to the grab rail for handset support and movement. Kit includes ABS Princess handpiece, PVC 1.5 m reinforced Softflex® spiral hose and wall outlet elbow which features 9 L/min Flow Interchange Spigot and separate licenced dual check/non return valves to prevent back siphonage.
	GS 191 P-ACC	Colour/Chrome	
	GS 191 P-ACG	Colour/Gold	
	GS 191 P-CG	Chrome/Gold	
 			
GS 191 F HOSFAB Please specify left or right hand			
 <p>Drawn left hand</p>  <p>Drawn right hand</p>	GS 191 F-C	Polish Supreme™	1170 mm x 1100 mm Polished Supreme™ inverted "T" grab rail, assembled with HYGIENIC SEAL® healthsafe flange covers and ABS Glide Slide Cradle fastened and tensioned to the grab rail for handset support and movement. Kit includes ABS Hosfab® handpiece, PVC 1.5 m reinforced Softflex® spiral hose and wall outlet elbow which features 9 L/min Flow Interchange Spigot and separate licenced dual check/non return valves to prevent back siphonage.
	GS 191 F-WTC	White/Chrome	
 			



PREMIUM HOSFAB® - HEALTHCARE SHOWER KIT WITH SLIDE TRACK & HANDSET CRADLE

900 mm Polished Supreme 304 grab rail/shower kit, assembled with 50 mm **HYGIENIC SEAL®** healthsafe flange covers and 685 mm **FRICTION SLIDE TRACK CRADLE** secured to the grab rail for handset support and movement and most suitable for persons with weakened wrists, arthritic and grip problems. The **HYGIENIC SEAL®** healthsafe flange covers with Thermoplastic Elastomer (TPE) fitted seal prevent grime such as soap scum, body fluids, ointments and aqueous based fluids accumulating behind the flange cover and creating possible serious health issues. Putting health and hygiene foremost, the grab rails comply with clause 17 of AS 1428.1-2009 for Design and Construction.



MODEL SHOWN GB 900 F - PREMIUM HOSFAB® KIT

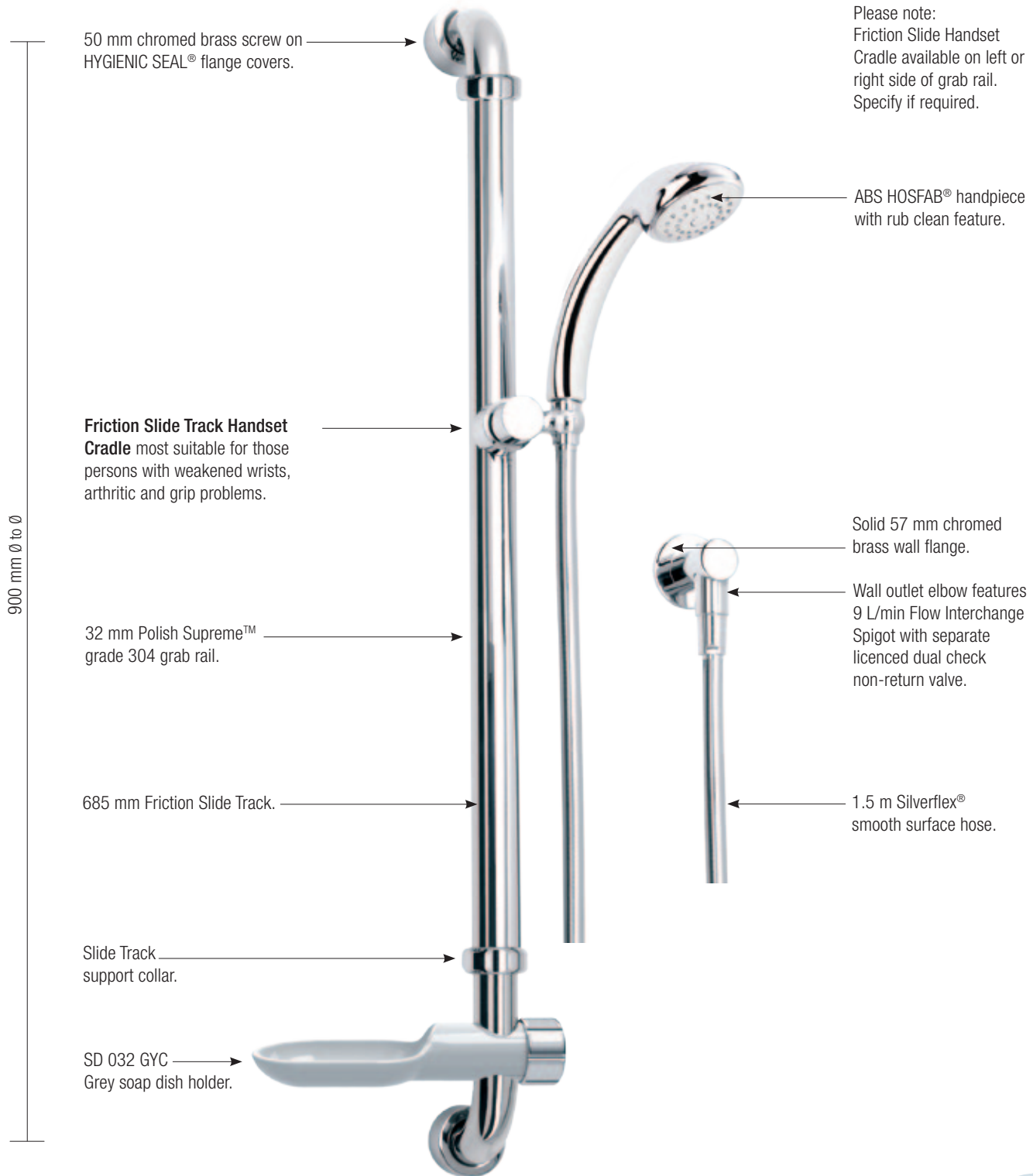

50 mm chromed brass screw on HYGIENIC SEAL® flange covers.

Please note:
Friction Slide Handset Cradle available on left or right side of grab rail. Specify if required.

ABS HOSFAB® handpiece with rub clean feature.

Friction Slide Track Handset Cradle most suitable for those persons with weakened wrists, arthritic and grip problems.

Solid 57 mm chromed brass wall flange.

Wall outlet elbow features 9 L/min Flow Interchange Spigot with separate licenced dual check non-return valve.

32 mm Polish Supreme™ grade 304 grab rail.

1.5 m Silverflex® smooth surface hose.

685 mm Friction Slide Track.

Slide Track support collar.

SD 032 GYC Grey soap dish holder.

Stainless steel screws and wall plugs provided.





PREMIUM HOSFAB® - SELECTIONS

700 mm x 1100 mm WITH FRICTION SLIDE TRACK & CRADLE

Home and healthcare shower selections with 700 mm x 1100 mm inverted "T" Polished Supreme™ grade 304 grab rail, assembled with the highest quality tested products and materials and feature dual check facilities as per AS/NZ 3500. Suits installations in hospitals, homes for the elderly and nursing homes. Selections comply with clause 17 of AS 1428.1-2009 for Design and Construction.



	Code	Finish	Features
GB 071 C - CHAMPAGNE PULSATOR Please specify left or right or centre fix			
<p>Drawn left hand</p> <p>Drawn right hand</p> <p>Drawn centre fix</p>	GB 071 C-C	Polish Supreme™	700 mm x 1100 mm Polished Supreme™ inverted "T" grab rail, assembled with HYGIENIC SEAL® healthsafe flange covers and 685 mm Friction Slide Track and Cradle secured to the grab rail for handset support and movement. Kit includes ABS Champagne Pulsator handpiece, PVC 1.5 m smooth Silverflex® or appropriate coloured spiral hose, a grabrail soap dish, wall outlet elbow which features 9 L/min Flow Interchange Spigot and separate licenced dual check/ non return valves to prevent back siphonage.
	GB 071 C-WTC	White/Chrome	
	GB 071 C-WTG	White/Gold	
	GB 071 C-CG	Chrome/Gold	
			3 Star - 9 L/min rated as per WELS licence number 0046.
GB 071 P - PRINCESS Please specify left or right or centre fix			
<p>Drawn left hand</p> <p>Drawn right hand</p> <p>Drawn centre fix</p>	GB 071 P-C	Polish Supreme™	700 mm x 1100 mm Polished Supreme™ inverted "T" grab rail, assembled with HYGIENIC SEAL® healthsafe flange covers and 685 mm Friction Slide Track and Cradle secured to the grab rail for handset support and movement. Kit includes ABS Princess handpiece, PVC 1.5 m smooth Silverflex® or appropriate coloured spiral hose, a grabrail soap dish, wall outlet elbow which features 9 L/min Flow Interchange Spigot and separate licenced dual check/non return valves to prevent back siphonage.
	GB 071 P-ACC	Colour/Chrome	
	GB 071 P-ACG	Colour/Gold	
	GB 071 P-CG	Chrome/Gold	
			3 Star - 9 L/min rated as per WELS licence number 0046.
GB 071 F - HOSFAB® Please specify left or right or centre fix			
<p>Drawn left hand</p> <p>Drawn right hand</p> <p>Drawn centre fix</p>	GB 071 F-C	Polish Supreme™	700 mm x 1100 mm Polished Supreme™ inverted "T" grab rail, assembled with HYGIENIC SEAL® healthsafe flange covers and 685 mm Friction Slide Track and Cradle secured to the grab rail for handset support and movement. Kit includes ABS Hosfab® handpiece, PVC 1.5 m smooth Silverflex® or appropriate coloured spiral hose, a grabrail soap dish, wall outlet elbow which features 9 L/min Flow Interchange Spigot and separate licenced dual check/non return valves to prevent back siphonage.
	GB 071 F-WTC	White/Chrome	
			3 Star - 9 L/min rated as per WELS licence number 0046.











PREMIUM HOSFAB® - SELECTIONS

760 mm x 1000 mm x 1100 mm

WITH FRICTION SLIDE TRACK & CRADLE

Home and healthcare shower selections with 760 mm x 1000 mm x 1100 mm Polished Supreme grade 304 grab rail, assembled with the highest quality tested products and materials and feature dual check facilities as per AS/NZ 3500. Suits installations in hospitals, homes for the elderly and nursing homes. Selections comply with clause 17 of AS 1428.1-2009 for Design and Construction.







	Code	Finish	Features
GB 711 C - CHAMPAGNE PULSATOR			
Please specify left or right hand			
 <p>Drawn right hand</p>  <p>Drawn left hand</p>	GB 711 C-C	Polish Supreme™	760 mm x 1000 mm x 1100 mm Polished Supreme™ grade 304 grab rail, assembled with HYGIENIC SEAL® healthsafe flange covers with 685 mm Friction Slide Track and Cradle secured to the grab rail for handset support and movement. Kit includes ABS Champagne Pulsator handpiece, PVC 1.5 m smooth Silverflex® or appropriate coloured spiral hose, a grab rail soap dish to suit and wall outlet elbow which features 9 L/min Flow Interchange Spigot and separate licenced dual check/non return valves to prevent back siphonage.
	GB 711 C-WTC	White/Chrome	
	GB 711 C-WTG	White/Gold	
	GB 711 C-CG	Chrome/Gold	
			
GB 711 P - PRINCESS			
Please specify left or right hand			
 <p>Drawn right hand</p>  <p>Drawn left hand</p>	GB 711 P-C	Polish Supreme™	760 mm x 1000 mm x 1100 mm Polished Supreme™ grade 304 grab rail, assembled with HYGIENIC SEAL® healthsafe flange covers with 685 mm Friction Slide Track and Cradle secured to the grab rail for handset support and movement. Kit includes ABS Princess handpiece, PVC 1.5 m smooth Silverflex® or appropriate coloured spiral hose, a grab rail soap dish to suit and wall outlet elbow which features 9 L/min Flow Interchange Spigot and separate licenced dual check/non return valves to prevent back siphonage.
	GB 711 P-ACC	Colour/Chrome	
	GB 711 P-ACG	Colour/Gold	
	GB 711 P-CG	Chrome/Gold	
			
GB 711 F - HOSFAB®			
Please specify left or right hand			
 <p>Drawn right hand</p>  <p>Drawn left hand</p>	GB 711 F-C	Polish Supreme™	760 mm x 1000 mm x 1100 mm Polished Supreme™ grade 304 grab rail, assembled with HYGIENIC SEAL® healthsafe flange covers with 685 mm Friction Slide Track and Cradle secured to the grab rail for handset support and movement. Kit includes ABS Hosfab® handpiece, PVC 1.5 m smooth Silverflex® or appropriate coloured spiral hose, a grab rail soap dish to suit and wall outlet elbow which features 9 L/min Flow Interchange Spigot and separate licenced dual check/non return valves to prevent back siphonage.
	GB 711 F-WTC	White/Chrome	
			



HEALTHCARE KIT ACCESSORIES

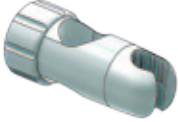
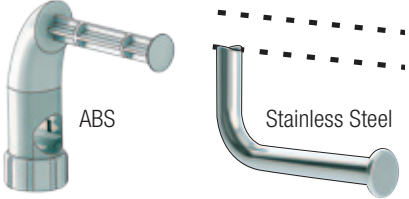

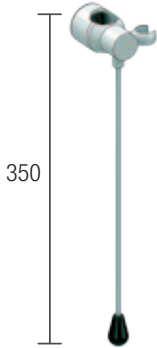
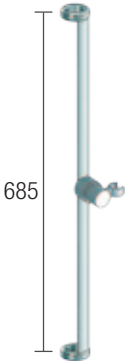

Con-Serv 32 mm grab rail exclusive products.



	Code	Finish	Features
SB 024 - GRAB RAIL GLIDE SLIDE HANDSET CRADLE			
	HC 024 BLC	Black/Chrome	<ul style="list-style-type: none"> • Fastens to 32 mm grab rail • Clicklock™ claw mechanism • ABS construction • Simple to clean
	HC 024 GYC	Grey/Chrome	
	HC 024 WT	White	
	HC 024 SC	Satin/Chrome	
	HC 024 ACG	Colour/Gold	
TR 031 - GRAB RAIL FLEXIBLE FIX AND STAINLESS STEEL TOILET ROLL HOLDER			
	TR 031 BLC	Black/Chrome	<ul style="list-style-type: none"> • Fastens to 32 mm grab rail • ABS construction • Simple to clean • Fits all 32 mm toilet assist grab rails
	TR 031 GYC	Grey/Chrome	
	TR 031 WT	White	
	TR 031 SC	Satin/Chrome	
	TR 031 ACG	Colour/Gold	
	TR 031 SS	Stainless Steel	
SD 032 - GRAB RAIL SOAP DISH HOLDER			
	SD 032 BLC	Black/Chrome	<ul style="list-style-type: none"> • Fastens to 32 mm grab rail • ABS construction • Simple to clean
	SD 032 GYC	Grey/Chrome	
	SD 032 WT	White	
	SD 032 SC	Satin/Chrome	
	SD 032 ACG	Colour/Gold	
PM 932 - PUSH-PULLME® SHOWER POSITIONING CRADLE WITH ROD			
 <p>350</p>	PM 932 C	Chrome	<p>Brass Friction Slide Cradle with PUSH-PULLME® shower height adjustment rod.</p> <p>To comply with requirements of AS 1428.1-2009 for person with disabilities (PWD), an adjustable shower head holder shall be provided to support the shower head and shall allow the graspable portion of the shower head to be positioned at various angles and heights and also allow the graspable portion of the shower head to be located at heights between 1000 mm and 1800 mm above the plane of the finished floor and allow access and adjustment from a seated position. The PUSH-PULLME® suits this requirement.</p> <p>FACTORY FITTED</p>
SR 685 - PREMIUM 685 mm FRICTION SLIDE TRACK CRADLE & COLLARS			
 <p>685</p>	SR 685 C	Chrome	<ul style="list-style-type: none"> • Brass construction • Cradle adjustment for handpiece • Smooth slide action • Self locking • Recommended for those persons with arthritic or grip problems. • No locking knob <p>FACTORY FITTED</p>
	SR 685 ACC	Colour/Chrome	
	SR 685 ACG	Colour/Gold	
	SR 685 SC	Satin Completely	
	SR 685 CG	Chrome/Gold	
	SR 685 G	Gold	
HP 049 - COLT WASH DOWN GUN			
	HP 049	Chrome/Black	<p>The colt trigger operated wash down gun with on/off lock function is robustly constructed and is built to last. The Colt has a maximum operating pressure of 550 Kpa (80 PSI) and maximum operating temperature of 55°C. Nozzle adjusts from narrow neck to wide pattern spray.</p> <p>NOT TO BE USED AS LINE END STOP CONTROL.</p>

½" BSP Nipple



	Code	Finish	Features	
HS 032 BE - HYGIENIC SEAL® BLANK END FLANGE				
	HS 032 BE	Chrome	Blank end tamperproof flange to cover Hygienic Seal® wall mount plate when the grab rail is removed, but will be required to be re-installed for use in a PWD requirement.	
HS 032 FC - HYGIENIC SEAL® FLANGE COVER				
	HS 032 FC	Chrome	50 mm Hygienic Seal® flange cover. Follow installation instruction guide, page 65, if replacement is required. The Hygienic Seal® is a thermodynamic product designed to eliminate the risk of bathroom debris getting behind the flange and becoming unsanitary, thereby causing or conveying infection. The Hygienic Seal® is intended to assist in the promotion of hygiene, particularly in environments where this is a critical issue.	
HS 032 MP - HYGIENIC SEAL® WALL MOUNT PLATE				
	HS 032 MP	Brass	Hygienic Seal® wall screw mount plate. Designed to rotate screw holes to suit stud or nogging. Stainless steel fixing screws supplied.	
TL 850 WM - TILTLOCK® "T" MOUNT BRACKET				
 <p style="display: flex; justify-content: space-around; margin-top: 5px;"> Right hand Left hand </p>	TL 850L WM	Brass/Nickle Plate	Concealed 4 fix nickle-plated brass "T" mount bracket secures TILTLOCK® to wall. Stainless steel fixing screws supplied.	
	TL 850R WM	Brass/Nickle Plate		
TL 850 WC - TILTLOCK® (TPE) "T" MOUNT COVER				
	TL 850 WC	White TPE	Thermo Plastic Elastomer (TPE) mount cover to conceal TILTLOCK® brass "T" mount bracket for when project specifications call for provision to be made for fold down rails to be installed at a further time.	
TL 850 US - TILTLOCK® FLOOR MOUNT UPSTAND				
	TL 850 US	Satin Stainless	Stainless steel floor mount upstand for mounting TILTLOCK® in Bariatric situations and when wall mounting is not possible. Stainless steel fixing screws supplied.	



CLAM FLANGE™ Grab Rails



Regular grab rail with 78 mm "CLAM FLANGE", domed cover, for the concealing of screw fixing points of the grab rail mount flange. The CLAM FLANGE™ snaps over notch lugs on the mount flange locking it firmly in place.

Con-Serv CLAM FLANGE™ grab rails are fabricated from 32 mm x 1.2 mm grade 304, 18/8 stainless steel, and pre-formed 75 mm 5 screw wall mount plate with 360 mm rear weld joint. Assembled with 78 mm domed CLAM FLANGE™ cover with 5 degree radius to comply with clause 17 of AS 1428.1-2009 for Design and Construction and available in the following finishes: Satin Supreme™, Polish Supreme™, Diamond Shur-Grip® and colours of choice.

Grab Rail Specifications

Outside Diameter

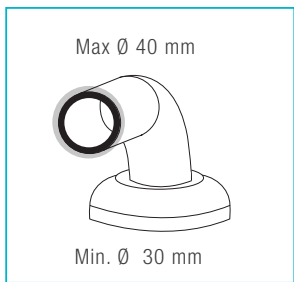

Grab rails should not be less than 30 mm and not more than 40 mm outside diameter, or they shall have sectional shape within the limits of 30 mm and 40 mm diameter.

Wall Clearance

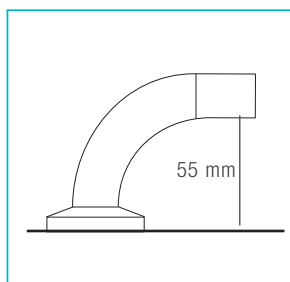

Unless otherwise specified, the clearance between grab rail and the adjacent wall surface or other obstruction shall not be less than 50 mm and not more than 60 mm. This clearance shall extend above the top of the grab rail by not less than 600 mm.

Mounting Height

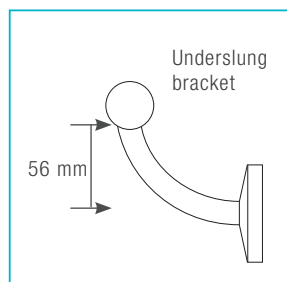

All horizontal fixings to be underslung brackets as per standard requirements.

Con-Serv grab rail underslung bracket is 56 mm below rail.

Minimum Obstruction

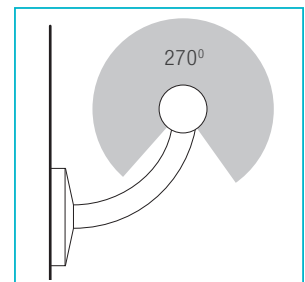

Grab rails shall be fixed so that there is no obstruction to the hand along the top 270 degrees of the rail.

Installation Instructions for Grab Rail with Clam Flange™

Grab rails with clam flange must be fitted to a solid wall or other firm surface and installed by a qualified trades person.

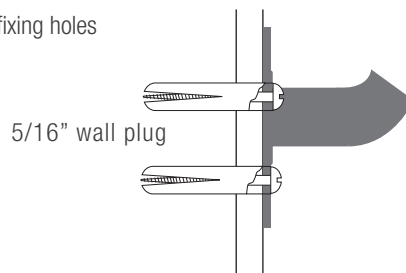
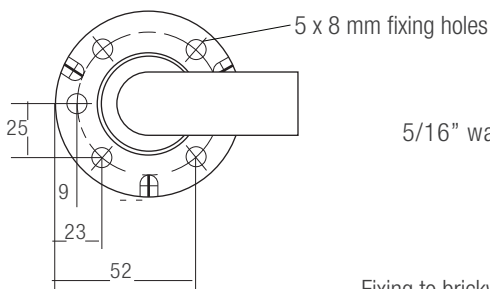

Fixing to brickwork, blockwork or concrete use stainless steel 50 mm x 14 g self tapping screws.

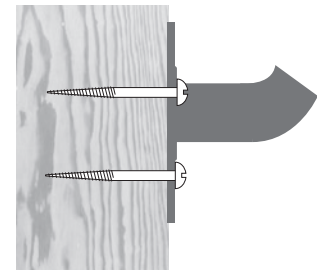

Fixing to timber use stainless steel 50 mm x 14 g self tapping screws.

Custom Made Grab Rail Measurement Instructions

1. Measure all bends to the centre line.
2. When designing any grab rail all measurements are centre to centre of the rail.
3. Dimensions should be clearly shown between rail centres or to wall corners.
4. For handed grab rails nominate left or right hand e.g. Toilet assist rails are sitting on the pan, not looking at it.

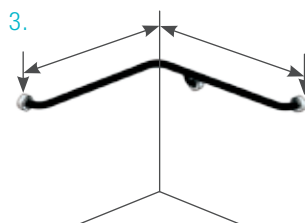
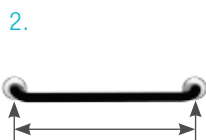
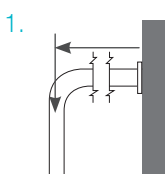

Drawn left hand

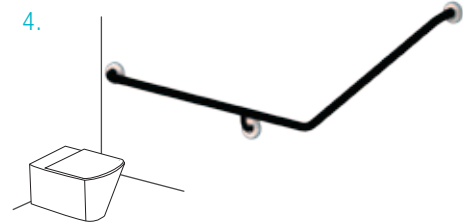

Drawn left hand



HYGIENIC SEAL® Grab Rails - Independence with Style



When health and hygiene matter most, HYGIENIC SEAL® grab rails lead the healthcare industry with Con-Serv's own, innovation cove designed Thermoplastic Elastomer (TPE) fitted flange seal that firms to the rail wall and when installed prevents grime, such as soap scum, body fluids, ointments and aqueous based fluids accumulating behind the grab rail flange covers and creating possible serious health issues.

Only Con-Serv® HYGIENIC SEAL® Safe-Assist® Grab Rails give this Promise. Be most cautious of claims made by imitators.

Con-Serv® HYGIENIC SEAL® Safe-Assist® grab rail collection is fabricated from 32 mm x 1.2 mm, grade 304, 18/8 stainless steel and assembled with a 50 mm, 3 part machined brass screw on flange cover with 5 degree radius to comply with clause 17 of AS 1428.1-2009 for Design and Construction and available in the following finishes: Satin Supreme™, Polish Supreme™, Diamond Shur-Grip® and colour of choice.

Tested by ETRS Pty Ltd for compliance to 1100 N mass in any position, without any permanent deformation, distortion or loosening of the fastenings. Test report registration number QRNOO-2847.

Installation Guide

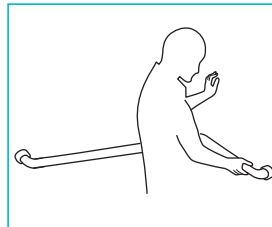

1. Install straight grab rails including the horizontal section of any grab rails as per AS 1428, 800-810 mm from floor to top of rail. Make sure wall surface is flat and free from contaminants.

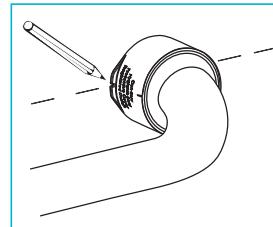

2. For STRAIGHT grab rails, position the flange protector guide lugs either vertical or horizontal. For CORNER grab rails, position the guide lugs horizontally "ONLY". Then mark at fixing guide lugs.

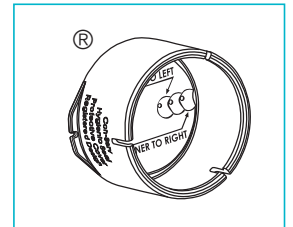

3. Remove flange protector from grab rail flange, align guide lug marks from step 2 and mark wall through base holes to pinpoint screw holes.

Design Registration number - 311119.

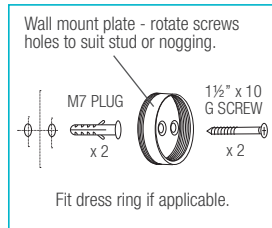

4. Drill spot marks with 7 mm bit. Plug and screw wall mount plate to wall stud, using the 304 stainless steel screws supplied.

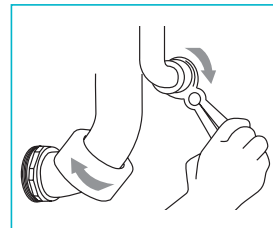

5. Fit grab rail into wall mount plate and tighten lock nut firmly.

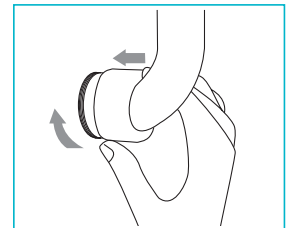

6. Screw flange cover to wall mount plate, to secure the Thermoplastic Elastomer fitted HYGIENIC SEAL®

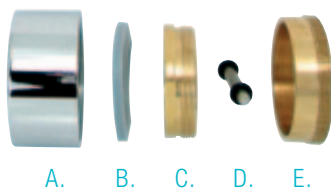

- A. Flange cover
- B. Thermoplastic Elastomer (the seal)
- C. Locking nut
- D. Locking pin
- E. Screw mount plate

Grab rails and shower support rails are installed to provide safe support for persons who require assistance in toilets as well as bathrooms and should comply on installation when fixed, to contribute to its ability to withstand the required 1100 Newton force placed upon it. Concrete or brick walls do not present a problem. If a building is constructed with either metal frame or timber it is useful to know the dimensions of the studs and noggings and the place between the studs. Con-Serv® HYGIENIC SEAL® wall mount fittings have two screw holes and can be positioned and fastened at any angle to suit the stud or nogging. TOGGLE BOLTS FIXED INTO TILES, PLASTER BOARD OR OTHER WATERPROOF WALLS ARE NOT SATISFACTORY OR SAFE. Grab rails with HYGIENIC SEAL® flange must be fitted to a solid wall or other firm surface and installed by a qualified trades person.



REGULAR - STRAIGHT GRAB RAILS

CLAM FLANGE™ Safe-Assist® 32 mm grab rails, fabricated from 304 stainless steel with 78 mm pre-formed domed Clam concealed flange. Manufactured to comply with clause 17 of AS 1428.1-2009 for design and construction. For horizontal fixing of grab rails, mount 800 mm to 810 mm above floor level.



	Code	Finish	Features
300 mm			
	CF 300 SS	Satin Supreme™	300 mm Ø to Ø Stainless steel fixing screws supplied.
	CF 300 PS	Polish Supreme™	
	CF 300 KG	Diamond Shur-Grip®	
	CF 300 FC	Full Colour	
400 mm			
	CF 400 SS	Satin Supreme™	400 mm Ø to Ø Stainless steel fixing screws supplied.
	CF 400 PS	Polish Supreme™	
	CF 400 KG	Diamond Shur-Grip®	
	CF 400 FC	Full Colour	
450 mm			
	CF 450 SS	Satin Supreme™	450 mm Ø to Ø Stainless steel fixing screws supplied.
	CF 450 PS	Polish Supreme™	
	CF 450 KG	Diamond Shur-Grip®	
	CF 450 FC	Full Colour	
500 mm			
	CF 500 SS	Satin Supreme™	500 mm Ø to Ø Stainless steel fixing screws supplied.
	CF 500 PS	Polish Supreme™	
	CF 500 KG	Diamond Shur-Grip®	
	CF 500 FC	Full Colour	
600 mm			
	CF 600 SS	Satin Supreme™	600 mm Ø to Ø Stainless steel fixing screws supplied.
	CF 600 PS	Polish Supreme™	
	CF 600 KG	Diamond Shur-Grip®	
	CF 600 FC	Full Colour	
700 mm			
	CF 700 SS	Satin Supreme™	700 mm Ø to Ø Stainless steel fixing screws supplied.
	CF 700 PS	Polish Supreme™	
	CF 700 KG	Diamond Shur-Grip®	
	CF 700 FC	Full Colour	



REGULAR - STRAIGHT GRAB RAILS

CLAM FLANGE™ Safe-Assist® 32 mm grab rails, fabricated from 304 stainless steel with 78 mm pre-formed domed Clam concealed flange. Manufactured to comply with clause 17 of AS 1428.1-2009 for design and construction. For horizontal fixing of grab rails, mount 800 mm to 810 mm above floor level.



	Code	Finish	Features
750 mm			
	CF 750 SS	Satin Supreme™	750 mm Ø to Ø Stainless steel fixing screws supplied.
	CF 750 PS	Polish Supreme™	
	CF 750 KG	Diamond Shur-Grip®	
	CF 750 FC	Full Colour	
800 mm			
	CF 800 SS	Satin Supreme™	800 mm Ø to Ø Stainless steel fixing screws supplied.
	CF 800 PS	Polish Supreme™	
	CF 800 KG	Diamond Shur-Grip®	
	CF 800 FC	Full Colour	
900 mm			
	CF 900 SS	Satin Supreme™	900 mm Ø to Ø Stainless steel fixing screws supplied.
	CF 900 PS	Polish Supreme™	
	CF 900 KG	Diamond Shur-Grip®	
	CF 900 FC	Full Colour	
1000 mm			
	CF 1000 SS	Satin Supreme™	1000 mm Ø to Ø Stainless steel fixing screws supplied.
	CF 1000 PS	Polish Supreme™	
	CF 1000 KG	Diamond Shur-Grip®	
	CF 1000 FC	Full Colour	
1100 mm			
	CF 1100 SS	Satin Supreme™	1100 mm Ø to Ø Stainless steel fixing screws supplied.
	CF 1100 PS	Polish Supreme™	
	CF 1100 KG	Diamond Shur-Grip®	
	CF 1100 FC	Full Colour	
1200 mm			
	CF 1200 SS	Satin Supreme™	1200 mm Ø to Ø Stainless steel fixing screws supplied.
	CF 1200 PS	Polish Supreme™	
	CF 1200 KG	Diamond Shur-Grip®	
	CF 1200 FC	Full Colour	



Optional extras: Toilet Roll Holders

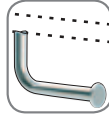

TR 031

TR 031 SS

Refer page 26

REGULAR - AMBULANT & TOILET GRAB RAILS

CLAM FLANGE™ Safe-Assist® 32 mm grab rails, fabricated from 304 stainless steel with 78 mm pre-formed domed Clam concealed flange. Manufactured to comply with clause 17 of AS 1428.1-2009 for design and construction. For horizontal fixing of grab rails, mount 800 mm to 810 mm above floor level.



450 mm x 450 mm	Code	Finish	Features
<p>Drawn left hand</p>	CF 045 SS	Satin Supreme™	450 mm x 450 mm Stainless steel fixing screws supplied. Suitable for left or right hand installation.
	CF 045 PS	Polish Supreme™	
	CF 045 KG	Diamond Shur-Grip®	
	CF 045 FC	Full Colour	
450 mm x 700 mm GRAB RAIL REQUIRED EACH SIDE OF TOILET			
Please specify left or right hand			
<p>Drawn left hand For ambulant disabilities.</p>	CF 457 SS	Satin Supreme™	450 mm x 700 mm Complies with requirements of AS 1428.1-2009 for water closets. Stainless steel fixing screws supplied.
	CF 457 PS	Polish Supreme™	
	CF 457 KG	Diamond Shur-Grip®	
	CF 457 FC	Full Colour	
700 mm x 700 mm			
Please specify left or right hand			
<p>Drawn left hand</p>	CF 077 SS	Satin Supreme™	700 mm x 700 mm Stainless steel fixing screws supplied.
	CF 077 PS	Polish Supreme™	
	CF 077 KG	Diamond Shur-Grip®	
	CF 077 FC	Full Colour	
870 mm x 700 mm			
Please specify left or right hand			
<p>Drawn left hand</p>	CF 877 SS	Satin Supreme™	870 mm x 700 mm Complies with requirements of AS 1428.1-2009 for water closets. Stainless steel fixing screws supplied.
	CF 877 PS	Polish Supreme™	
	CF 877 KG	Diamond Shur-Grip®	
	CF 877 FC	Full Colour	
940 mm x 700 mm			
Please specify left or right hand			
<p>Drawn left hand Note: Horizontal flange connects directly to rear wall.</p>	CF 947 SS	Satin Supreme™	940 mm x 700 mm Complies with requirements of AS 1428.1-2009 for water closets. Stainless steel fixing screws supplied.
	CF 947 PS	Polish Supreme™	
	CF 947 KG	Diamond Shur-Grip®	
	CF 947 FC	Full Colour	
1110 mm x 940 mm x 700 mm			
Please specify left or right hand			
<p>Drawn left hand Suits Backrest installation</p>	CF 197 SS	Satin Supreme™	1110 mm x 940 mm x 700 mm centre to wall corner Complies with requirements of AS 1428.1-2009 for water closets. Stainless steel fixing screws supplied.
	CF 197 PS	Polish Supreme™	
	CF 197 KG	Diamond Shur-Grip®	
	CF 197 FC	Full Colour	



Optional extras: Toilet Roll Holders



TR 031

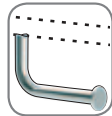

TR 031 SS

Refer page 26

REGULAR - AMBULANT & TOILET GRAB RAILS

CLAM FLANGE™ Safe-Assist® 32 mm grab rails, fabricated from 304 stainless steel with 78 mm pre-formed domed Clam concealed flange. Manufactured to comply with clause 17 of AS 1428.1-2009 for design and construction. For horizontal fixing of grab rails, mount 800 mm to 810 mm above floor level.



	Code	Finish	Features
450 mm x 450 mm			
<p>Drawn left hand</p> <p>For ambulant disabilities</p>	CF 454 SS	Satin Supreme™	450 mm x 450 mm Complies with requirements of AS 1428.1-2009 for water closets. Stainless steel fixing screws supplied.
	CF 454 PS	Polish Supreme™	
	CF 454 KG	Diamond Shur-Grip®	
	CF 454 FC	Full Colour	
400 mm x 600 mm			
Please specify left or right hand			
<p>Drawn left hand</p>	CF 046 SS	Satin Supreme™	400 mm x 600 mm Stainless steel fixing screws supplied.
	CF 046 PS	Polish Supreme™	
	CF 046 KG	Diamond Shur-Grip®	
	CF 046 FC	Full Colour	
600 mm x 600 mm			
Please specify left or right hand			
<p>Drawn left hand</p>	CF 606 SS	Satin Supreme™	600 mm x 600 mm Stainless steel fixing screws supplied.
	CF 606 PS	Polish Supreme™	
	CF 606 KG	Diamond Shur-Grip®	
	CF 606 FC	Full Colour	
960 mm x 600 mm			
Please specify left or right hand			
<p>Drawn left hand</p>	CF 966 SS	Satin Supreme™	960 mm x 600 mm Complies with requirements of AS 1428.1-2009 for water closets. Stainless steel fixing screws supplied.
	CF 966 PS	Polish Supreme™	
	CF 966 KG	Diamond Shur-Grip®	
	CF 966 FC	Full Colour	
1030 mm x 600 mm			
Please specify left or right hand			
<p>Drawn left hand</p> <p>Note: Horizontal flange connects directly to rear wall.</p>	CF 106 SS	Satin Supreme™	1030 mm x 600 mm Complies with requirements of AS 1428.1-2009 for water closets. Stainless steel fixing screws supplied.
	CF 106 PS	Polish Supreme™	
	CF 106 KG	Diamond Shur-Grip®	
	CF 106 FC	Full Colour	
1110 mm x 1030 mm x 600 mm			
Please specify left or right hand			
<p>Drawn left hand</p> <p>Suits Backrest installation</p>	CF 116 SS	Satin Supreme™	1110 mm x 1030 mm x 600 mm centre to wall corner Complies with requirements of AS 1428.1-2009 for water closets. Stainless steel fixing screws supplied.
	CF 116 PS	Polish Supreme™	
	CF 116 KG	Diamond Shur-Grip®	
	CF 116 FC	Full Colour	





REGULAR - CORNER GRAB RAILS

CLAM FLANGE™ Safe-Assist® 32 mm grab rails, fabricated from 304 stainless steel with 78 mm pre-formed domed Clam concealed flange. Manufactured to comply with clause 17 of AS 1428.1-2009 for design and construction. For horizontal fixing of grab rails, mount 800 mm to 810 mm above floor level.



	Code	Finish	Features
600 mm x 600 mm			
<p>Drawn left hand</p>	Please specify left or right hand		
	CF 660 SS	Satin Supreme™	MADE TO ORDER NON-RETURNABLE
	CF 660 PS	Polish Supreme™	600 mm x 600 mm centre to wall corner Stainless steel fixing screws supplied.
	CF 660 KG	Diamond Shur-Grip®	
	CF 660 FC	Full Colour	
700 mm x 700 mm			
<p>Drawn left hand</p>	Please specify left or right hand		
	CF 770 SS	Satin Supreme™	MADE TO ORDER NON-RETURNABLE
	CF 770 PS	Polish Supreme™	700 mm x 700 mm centre to wall corner Stainless steel fixing screws supplied.
	CF 770 KG	Diamond Shur-Grip®	
	CF 770 FC	Full Colour	
750 mm x 750 mm			
<p>Drawn left hand</p>	Please specify left or right hand		
	CF 757 SS	Satin Supreme™	MADE TO ORDER NON-RETURNABLE
	CF 757 PS	Polish Supreme™	750 mm x 750 mm centre to wall corner Stainless steel fixing screws supplied.
	CF 757 KG	Diamond Shur-Grip®	
	CF 757 FC	Full Colour	
800 mm x 800 mm			
<p>Drawn left hand</p>	Please specify left or right hand		
	CF 880 SS	Satin Supreme™	MADE TO ORDER NON-RETURNABLE
	CF 880 PS	Polish Supreme™	800 mm x 800 mm centre to wall corner Stainless steel fixing screws supplied.
	CF 880 KG	Diamond Shur-Grip®	
	CF 880 FC	Full Colour	
760 mm x 1000 mm			
<p>Drawn left hand</p>	Please specify left or right hand		
	CF 761 SS	Satin Supreme™	760 mm x 1000 mm centre to wall corner Stainless steel fixing screws supplied.
	CF 761 PS	Polish Supreme™	
	CF 761 KG	Diamond Shur-Grip®	
	CF 761 FC	Full Colour	



REGULAR - SHOWER RECESS GRAB RAILS

CLAM FLANGE™ Safe-Assist® 32 mm grab rails, fabricated from 304 stainless steel with 78 mm pre-formed domed Clam concealed flange. Manufactured to comply with clause 17 of AS 1428.1-2009 for design and construction. For horizontal fixing of grab rails, mount 800 mm to 810 mm above floor level.



Optional extra: SD 032 Soap Dish

Code	Finish	Features
400 mm x 1100 mm "L" SHAPE		
Please specify left or right hand		
CF 041 SS	Satin Supreme™	MADE TO ORDER NON-RETURNABLE 400 mm x 1100 mm "L" shape grab rail. Stainless steel fixing screws supplied.
CF 041 PS	Polish Supreme™	
CF 041 KG	Diamond Shur-Grip®	
CF 041 FC	Full Colour	
700 mm x 1100 mm INVERTED "T"		
Please specify left or right or centre fix		
CF 071 SS	Satin Supreme™	TO SUIT SINGLE ACCESSIBLE SHOWER RECESS 700 mm x 1100 mm Inverted "T" grab rail. Left and right hand models only comply with AS 1428.1-2009 for a 2 walled shower enclosure. Stainless steel fixing screws supplied.
CF 071 PS	Polish Supreme™	
CF 071 KG	Diamond Shur-Grip®	
CF 071 FC	Full Colour	
1170 mm x 1100 mm INVERTED "T"		
Please specify left or right hand		
CF 191 SS	Satin Supreme™	TO SUIT COMBINED ACCESSIBLE SANITARY COMPARTMENT 1170 mm x 1100 mm Inverted "T" grab rail. Complies with requirements of AS 1428.1-2009 for a 2 walled shower enclosure. Stainless steel fixing screws supplied.
CF 191 PS	Polish Supreme™	
CF 191 KG	Diamond Shur-Grip®	
CF 191 FC	Full Colour	
760 mm x 1000 mm x 1100 mm SHOWER RECESS		
Please specify left or right hand		
CF 711 SS	Satin Supreme™	TO SUIT CORNER SHOWER RECESS 760 mm x 1000 mm x 1100 mm centre to wall corner grab rail. Stainless steel fixing screws supplied.
CF 711 PS	Polish Supreme™	
CF 711 KG	Diamond Shur-Grip®	
CF 711 FC	Full Colour	



PREMIUM - STRAIGHT GRAB RAILS

 **HYGIENIC SEAL®** Safe-Assist® 32 mm grab rails, fabricated from 304 stainless steel and assembled with 50 mm brass screw on flange covers with Thermoplastic Elastomer (TPE) fitted seals. The seals firm to the rail wall and prevent the accumulation of unhealthy grime. The HYGIENIC SEAL® grab rail complies with clause 17 of AS 1428.1-2009 for Design and Construction. Mount grab rail 800 mm to 810 mm above floor level.

	Code	Finish	Features
200 mm			
	HS 200 SS	Satin Supreme™	 200 mm Ø to Ø Stainless steel fixing screws supplied.
	HS 200 PS	Polish Supreme™	
	HS 200 KG	Diamond Shur-Grip®	
	HS 200 FC	Full Colour	
	HS 200 GG	Gold	
300 mm			
	HS 300 SS	Satin Supreme™	 300 mm Ø to Ø Stainless steel fixing screws supplied.
	HS 300 PS	Polish Supreme™	
	HS 300 KG	Diamond Shur-Grip®	
	HS 300 AC	Colour/chrome flange covers	
	HS 300 FC	Full colour	
	HS 300 AG	Colour/gold dress rings	
HS 300 GG	Gold		
400 mm			
	HS 400 SS	Satin Supreme™	 400 mm Ø to Ø Stainless steel fixing screws supplied.
	HS 400 PS	Polish Supreme™	
	HS 400 KG	Diamond Shur-Grip®	
	HS 400 AC	Colour/chrome flange covers	
	HS 400 FC	Full colour	
	HS 400 AG	Colour/gold dress rings	
HS 400 GG	Gold		
450 mm			
	HS 450 SS	Satin Supreme™	 450 mm Ø to Ø Stainless steel fixing screws supplied.
	HS 450 PS	Polish Supreme™	
	HS 450 KG	Diamond Shur-Grip®	
	HS 450 AC	Colour/chrome flange covers	
	HS 450 FC	Full colour	
	HS 450 AG	Colour/gold dress rings	
HS 450 GG	Gold		
500 mm			
	HS 500 SS	Satin Supreme™	 500 mm Ø to Ø Stainless steel fixing screws supplied.
	HS 500 PS	Polish Supreme™	
	HS 500 KG	Diamond Shur-Grip®	
	HS 500 AC	Colour/chrome flange covers	
	HS 500 FC	Full colour	
	HS 500 AG	Colour/gold dress rings	
HS 500 GG	Gold		
600 mm			
	HS 600 SS	Satin Supreme™	 600 mm Ø to Ø Stainless steel fixing screws supplied.
	HS 600 PS	Polish Supreme™	
	HS 600 KG	Diamond Shur-Grip®	
	HS 600 AC	Colour/chrome flange covers	
	HS 600 FC	Full colour	
	HS 600 AG	Colour/gold dress rings	
HS 600 GG	Gold		
700 mm			
	HS 700 SS	Satin Supreme™	 700 mm Ø to Ø Stainless steel fixing screws supplied.
	HS 700 PS	Polish Supreme™	
	HS 700 KG	Diamond Shur-Grip®	
	HS 700 AC	Colour/chrome flange covers	
	HS 700 FC	Full colour	
	HS 700 AG	Colour/gold dress rings	
HS 700 GG	Gold		



PREMIUM - STRAIGHT GRAB RAILS

 **HYGIENIC SEAL®** Safe-Assist® 32 mm grab rails, fabricated from 304 stainless steel and assembled with 50 mm brass screw on flange covers with Thermoplastic Elastomer (TPE) fitted seals. The seals firm to the rail wall and prevent the accumulation of unhealthy grime. The HYGIENIC SEAL® grab rail complies with clause 17 of AS 1428.1-2009 for Design and Construction. Mount grab rail 800 mm to 810 mm above floor level.



	Code	Finish	Features
750 mm			
	HS 750 SS	Satin Supreme™	750 mm Ø to Ø Stainless steel fixing screws supplied.
	HS 750 PS	Polish Supreme™	
	HS 750 KG	Diamond Shur-Grip®	
	HS 750 AC	Colour/chrome flange covers	
	HS 750 FC	Full colour	
	HS 750 AG	Colour/gold dress rings	
	HS 750 GG	Gold	
800 mm			
	HS 800 SS	Satin Supreme™	800 mm Ø to Ø Stainless steel fixing screws supplied.
	HS 800 PS	Polish Supreme™	
	HS 800 KG	Diamond Shur-Grip®	
	HS 800 AC	Colour/chrome flange covers	
	HS 800 FC	Full colour	
	HS 800 AG	Colour/gold dress rings	
	HS 800 GG	Gold	
900 mm			
	HS 900 SS	Satin Supreme™	900 mm Ø to Ø Stainless steel fixing screws supplied.
	HS 900 PS	Polish Supreme™	
	HS 900 KG	Diamond Shur-Grip®	
	HS 900 AC	Colour/chrome flange covers	
	HS 900 FC	Full colour	
	HS 900 SC	Satin Chrome	
	HS 900 AG	Colour/gold dress rings	
HS 900 GG	Gold		
1000 mm			
	HS 1000 SS	Satin Supreme™	1000 mm Ø to Ø Stainless steel fixing screws supplied.
	HS 1000 PS	Polish Supreme™	
	HS 1000 KG	Diamond Shur-Grip®	
	HS 1000 AC	Colour/chrome flange covers	
	HS 1000 FC	Full colour	
	HS 1000 AG	Colour/gold dress rings	
	HS 1000 GG	Gold	
1100 mm			
	HS 1100 SS	Satin Supreme™	1100 mm Ø to Ø Stainless steel fixing screws supplied.
	HS 1100 PS	Polish Supreme™	
	HS 1100 KG	Diamond Shur-Grip®	
	HS 1100 AC	Colour/chrome flange covers	
	HS 1100 FC	Full colour	
	HS 1100 AG	Colour/gold dress rings	
	HS 1100 GG	Gold	
1200 mm			
	HS 1200 SS	Satin Supreme™	1200 mm Ø to Ø Stainless steel fixing screws supplied.
	HS 1200 PS	Polish Supreme™	
	HS 1200 KG	Diamond Shur-Grip®	
	HS 1200 AC	Colour/chrome flange covers	
	HS 1200 FC	Full colour	
	HS 1200 AG	Colour/gold dress rings	
	HS 1200 GG	Gold	





Optional extras: Toilet Roll Holders

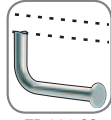

TR 031

TR 031 SS

Refer page 26

PREMIUM - AMBULANT & TOILET GRAB RAILS

HYGIENIC SEAL® Safe-Assist® 32 mm grab rails. Fabricated from 304 stainless steel and assembled with 50 mm brass screw on flange covers with Thermoplastic Elastomer (TPE) fitted seals. The seals firm to the rail wall and prevent the accumulation of unhealthy grime. The HYGIENIC SEAL® grab rail complies with clause 17 of AS 1428.1-2009 for Design and Construction. Mount horizontal section of rail 800 mm to 810 mm above floor level.



	Code	Finish	Features
450 mm x 450 mm <p>Drawn left hand</p>	HS 045 SS HS 045 PS HS 045 KG HS 045 AC HS 045 FC HS 045 AG	Satin Supreme™ Polish Supreme™ Diamond Shur-Grip® Colour/chrome flange covers Full colour Colour/gold dress rings	450 mm x 450 mm Stainless steel fixing screws supplied. Suitable for left or right hand installation.
450 mm x 700 mm <p>Drawn left hand For ambulant disabilities.</p>	Please specify left or right hand HS 457 SS HS 457 PS HS 457 KG HS 457 AC HS 457 FC HS 457 AG		450 mm x 700 mm Complies with requirements of AS 1428.1-2009 for water closets. Stainless steel fixing screws supplied.
700 mm x 700 mm <p>Drawn left hand</p>	Please specify left or right hand HS 077 SS HS 077 PS HS 077 KG HS 077 AC HS 077 FC HS 077 AG		700 mm x 700 mm Stainless steel fixing screws supplied.
870 mm x 700 mm <p>Drawn left hand</p>	Please specify left or right hand HS 877 SS HS 877 PS HS 877 KG HS 877 AC HS 877 FC HS 877 AG		870 mm x 700 mm Complies with requirements of AS 1428.1-2009 for water closets. Stainless steel fixing screws supplied.
940 mm x 700 mm <p>Drawn left hand Note: Horizontal flange connects directly to rear wall.</p>	Please specify left or right hand HS 947 SS HS 947 PS HS 947 KG HS 947 AC HS 947 FC HS 947 AG		940 mm x 700 mm Complies with requirements of AS 1428.1-2009 for water closets. Stainless steel fixing screws supplied.
1110 mm x 940 mm x 700 mm <p>Drawn left hand Suits Backrest installation</p>	Please specify left or right hand HS 197 SS HS 197 PS HS 197 KG HS 197 AC HS 197 FC HS 197 AG		1110 mm x 940 mm x 700 mm centre to wall corner Complies with requirements of AS 1428.1-2009 for water closets. Stainless steel fixing screws supplied.



Optional extras: Toilet Roll Holders



TR 031











TR 031 SS

Refer page 26

PREMIUM - AMBULANT & TOILET GRAB RAILS

HYGIENIC SEAL® Safe-Assist® 32 mm grab rails. Fabricated from 304 stainless steel and assembled with 50 mm brass screw on flange covers with Thermoplastic Elastomer (TPE) fitted seals. The seals firm to the rail wall and prevent the accumulation of unhealthy grime. The HYGIENIC SEAL® grab rail complies with clause 17 of AS 1428.1-2009 for Design and Construction. Mount horizontal section of rail 800 mm to 810 mm above floor level.



	Code	Finish	Features
<p>Drawn left hand</p> <p>For ambulant disabilities</p>	Please specify left or right hand		
	HS 454 SS	Satin Supreme™	450 mm x 450 mm Complies with requirements of AS 1428.1-2009 for water closets. Stainless steel fixing screws supplied.  
	HS 454 PS	Polish Supreme™	
	HS 454 KG	Diamond Shur-Grip®	
	HS 454 AC	Colour/chrome flange covers	
	HS 454 FC	Full colour	
	HS 454 AG	Colour/gold dress rings	
<p>Drawn left hand</p>	Please specify left or right hand		
	HS 046 SS	Satin Supreme™	400 mm x 600 mm Stainless steel fixing screws supplied. 
	HS 046 PS	Polish Supreme™	
	HS 046 KG	Diamond Shur-Grip®	
	HS 046 AC	Colour/chrome flange covers	
	HS 046 FC	Full colour	
	HS 046 AG	Colour/gold dress rings	
<p>Drawn left hand</p>	Please specify left or right hand		
	HS 606 SS	Satin Supreme™	600 mm x 600 mm Stainless steel fixing screws supplied. 
	HS 606 PS	Polish Supreme™	
	HS 606 KG	Diamond Shur-Grip®	
	HS 606 AC	Colour/chrome flange covers	
	HS 606 FC	Full colour	
	HS 606 AG	Colour/gold dress rings	
<p>Drawn left hand</p>	Please specify left or right hand		
	HS 966 SS	Satin Supreme™	960 mm x 600 mm Complies with requirements of AS 1428.1-2009 for water closets. Stainless steel fixing screws supplied.  
	HS 966 PS	Polish Supreme™	
	HS 966 KG	Diamond Shur-Grip®	
	HS 966 AC	Colour/chrome flange covers	
	HS 966 FC	Full colour	
	HS 966 AG	Colour/gold dress rings	
<p>Drawn left hand</p> <p>Note: Horizontal flange connects directly to rear wall.</p>	Please specify left or right hand		
	HS 106 SS	Satin Supreme™	1030 mm x 600 mm Complies with requirements of AS 1428.1-2009 for water closets. Stainless steel fixing screws supplied.  
	HS 106 PS	Polish Supreme™	
	HS 106 KG	Diamond Shur-Grip®	
	HS 106 AC	Colour/chrome flange covers	
	HS 106 FC	Full colour	
	HS 106 AG	Colour/gold dress rings	
<p>Drawn left hand</p> <p>Suits Backrest installation</p>	Please specify left or right hand		
	HS 116 SS	Satin Supreme™	1110 mm x 1030 mm x 600 mm centre to wall corner Complies with requirements of AS 1428.1-2009 for water closets. Stainless steel fixing screws supplied.  
	HS 116 PS	Polish Supreme™	
	HS 116 KG	Diamond Shur-Grip®	
	HS 116 AC	Colour/chrome flange covers	
	HS 116 FC	Full colour	
	HS 116 AG	Colour/gold dress rings	



PREMIUM - CORNER GRAB RAILS

HYGIENIC SEAL® Safe-Assist® 32 mm grab rails. Fabricated from 304 stainless steel and assembled with 50 mm brass screw on flange covers with Thermoplastic Elastomer (TPE) fitted seals. The seals firm to the rail wall and prevent the accumulation of unhealthy grime. The HYGIENIC SEAL® grab rail complies with clause 17 of AS 1428.1-2009 for Design and Construction. Mount horizontal section of rail 800 mm to 810 mm above floor level.



	Code	Finish	Features
<p>Drawn left hand</p>	Please specify left or right hand		<p>MADE TO ORDER NON-RETURNABLE</p> <p>600 mm x 600 mm centre to wall corner Stainless steel fixing screws supplied.</p>
	HS 660 SS	Satin Supreme™	
	HS 660 PS	Polish Supreme™	
	HS 660 KG	Diamond Shur-Grip®	
	HS 660 AC	Colour/chrome flange covers	
	HS 660 FC	Full colour	
	HS 660 AG	Colour/gold dress rings	
<p>Drawn left hand</p>	Please specify left or right hand		<p>MADE TO ORDER NON-RETURNABLE</p> <p>700 mm x 700 mm centre to wall corner Stainless steel fixing screws supplied.</p>
	HS 770 SS	Satin Supreme™	
	HS 770 PS	Polish Supreme™	
	HS 770 KG	Diamond Shur-Grip®	
	HS 770 AC	Colour/chrome flange covers	
	HS 770 FC	Full colour	
	HS 770 AG	Colour/gold dress rings	
<p>Drawn left hand</p>	Please specify left or right hand		<p>MADE TO ORDER NON-RETURNABLE</p> <p>750 mm x 750 mm centre to wall corner Stainless steel fixing screws supplied.</p>
	HS 757 SS	Satin Supreme™	
	HS 757 PS	Polish Supreme™	
	HS 757 KG	Diamond Shur-Grip®	
	HS 757 AC	Colour/chrome flange covers	
	HS 757 FC	Full colour	
	HS 757 AG	Colour/gold dress rings	
<p>Drawn left hand</p>	Please specify left or right hand		<p>MADE TO ORDER NON-RETURNABLE</p> <p>800 mm x 800 mm centre to wall corner Stainless steel fixing screws supplied.</p>
	HS 880 SS	Satin Supreme™	
	HS 880 PS	Polish Supreme™	
	HS 880 KG	Diamond Shur-Grip®	
	HS 880 AC	Colour/chrome flange covers	
	HS 880 FC	Full colour	
	HS 880 AG	Colour/gold dress rings	
<p>Drawn left hand</p>	Please specify left or right hand		<p>760 mm x 1000 mm centre to wall corner Stainless steel fixing screws supplied.</p>
	HS 761 SS	Satin Supreme™	
	HS 761 PS	Polish Supreme™	
	HS 761 KG	Diamond Shur-Grip®	
	HS 761 AC	Colour/chrome flange covers	
	HS 761 FC	Full colour	
	HS 761 AG	Colour/gold dress rings	



PREMIUM - SHOWER RECESS GRAB RAILS

HYGIENIC SEAL® Safe-Assist® 32 mm grab rails. Fabricated from 304 stainless steel and assembled with 50 mm brass screw on flange covers with Thermoplastic Elastomer (TPE) fitted seals. The seals firm to the rail wall and prevent the accumulation of unhealthy grime. The HYGIENIC SEAL® grab rail complies with clause 17 of AS 1428.1-2009 for Design and Construction. Mount horizontal section of rail 800 mm to 810 mm above floor level.



Optional extra: SD 032 Soap Dish



	Code	Finish	Features
400 mm x 1100 mm "L" SHAPE			
<p>Drawn left hand Drawn right hand</p>	Please specify left or right hand		<p>MADE TO ORDER NON-RETURNABLE</p> <p>400 mm x 1100 mm "L" shape grab rail. Stainless steel fixing screws supplied.</p>
	HS 041 SS	Satin Supreme™	
	HS 041 PS	Polish Supreme™	
	HS 041 KG	Diamond Shur-Grip®	
	HS 041 AC	Colour/chrome flange covers	
	HS 041 FC	Full colour	
	HS 041 AG	Colour/gold dress rings	
700 mm x 1100 mm INVERTED "T"			
<p>Drawn left hand Centre Drawn right hand</p>	Please specify left or right or centre fix		<p>TO SUIT SINGLE ACCESSIBLE SHOWER RECESS</p> <p>700 mm x 1100 mm Inverted "T" grab rail. Left and right hand models only comply with AS 1428.1-2009 for a 2 walled shower enclosure. Stainless steel fixing screws supplied.</p>
	HS 071 SS	Satin Supreme™	
	HS 071 PS	Polish Supreme™	
	HS 071 KG	Diamond Shur-Grip®	
	HS 071 AC	Colour/chrome flange covers	
	HS 071 FC	Full colour	
	HS 071 AG	Colour/gold dress rings	
1170 mm x 1100 mm INVERTED "T"			
<p>Drawn left hand Drawn right hand</p>	Please specify left or right hand		<p>TO SUIT COMBINED ACCESSIBLE SANITARY COMPARTMENT</p> <p>1170 mm x 1100 mm Inverted "T" grab rail. Complies with requirements of AS 1428.1-2009 for a 2 walled shower enclosure. Stainless steel fixing screws supplied.</p>
	HS 191 SS	Satin Supreme™	
	HS 191 PS	Polish Supreme™	
	HS 191 KG	Diamond Shur-Grip®	
	HS 191 AC	Colour/chrome flange covers	
	HS 191 FC	Full colour	
	HS 191 AG	Colour/gold dress rings	
760 mm x 1000 mm x 1100 mm SHOWER RECESS			
<p>Drawn left hand Drawn right hand</p>	Please specify left or right hand		<p>TO SUIT CORNER SHOWER RECESS</p> <p>760 mm x 1000 mm x 1100 mm centre to wall corner grab rail. Stainless steel fixing screws supplied.</p>
	HS 711 SS	Satin Supreme™	
	HS 711 PS	Polish Supreme™	
	HS 711 KG	Diamond Shur-Grip®	
	HS 711 AC	Colour/chrome flange covers	
	HS 711 FC	Full Colour	
	HS 711 AG	Colour/gold dress rings	



PREMIUM - GRAB RAIL WITH TOWEL RAIL

HYGIENIC SEAL® Safe-Assist 32 mm grab rail with 19 mm towel rail. Fabricated from 304 stainless steel and assembled with 50 mm brass screw on flange covers with Thermoplastic Elastomer (TPE) fitted seals. The seals firm to the rail wall and prevent the accumulation of unhealthy grime. The HYGIENIC SEAL® grab rail complies with clause 17 of AS 1428.1-2009 for Design and Construction. Mount horizontal section of rail 800 mm to 810 mm above floor level.



	Code	Finish	Features
600 mm x 19 mm "D" SHAPE			
	HS 619 SS	Satin Supreme™	600 mm "D" shape Ø to Ø <ul style="list-style-type: none"> Towel rail 19 mm Overall width - 650 mm Overall depth - 161 mm Stainless steel fixing screws supplied.
	HS 619 PS	Polish Supreme™	
800 mm x 19 mm "D" SHAPE			
	HS 819 SS	Satin Supreme™	800 mm "D" shape Ø to Ø <ul style="list-style-type: none"> Towel rail 19 mm Overall width - 850 mm Overall depth - 161 mm Stainless steel fixing screws supplied.
	HS 819 PS	Polish Supreme™	
1000 mm x 19 mm "D" SHAPE			
	HS 109 SS	Satin Supreme™	1000 mm "D" shape Ø to Ø <ul style="list-style-type: none"> Towel rail 19 mm Overall width - 1050 mm Overall depth - 161 mm Stainless steel fixing screws supplied.
	HS 109 PS	Polish Supreme™	
1200 mm x 19 mm "D" SHAPE			
	HS 129 SS	Satin Supreme™	1200 mm "D" shape Ø to Ø <ul style="list-style-type: none"> Towel rail 19 mm Overall width - 1250 mm Overall depth - 161 mm Stainless steel fixing screws supplied.
	HS 129 PS	Polish Supreme™	



PREMIUM - LINEAR GRAB RAIL OPTIONS

 **LINEAR** style Safe-Assist® 32 mm grab rails and shower kits. Fabricated from 304 stainless steel and assembled with 50 mm brass screw on "T" leg LINEAR flange with fitted seals which prevent the accumulation of unhealthy grime. The LINEAR grab rails comply with clause 17 of AS 1428.1-2009 for Design and Construction. Mount horizontal section of rail 800 mm to 810 mm above the floor.



	Code	Finish	Features
STRAIGHT GRAB RAILS			
	LR 200 SS	Satin Supreme™	200 mm Ø to Ø - Straight grab rail
	LR 200 PS	Polish Supreme™	300 mm Ø to Ø - Straight grab rail
	LR 300 SS	Satin Supreme™	450 mm Ø to Ø - Straight grab rail
	LR 300 PS	Polish Supreme™	600 mm Ø to Ø - Straight grab rail
	LR 450 SS	Satin Supreme™	900 mm Ø to Ø - Straight grab rail
	LR 450 PS	Polish Supreme™	Add 55 mm for each capped extension. Stainless steel fixing screws supplied.
	LR 600 SS	Satin Supreme™	
	LR 600 PS	Polish Supreme™	
	LR 900 SS	Satin Supreme™	
	LR 900 PS	Polish Supreme™	
870 mm x 700 mm TOILET ASSIST GRAB RAIL			
Please specify left or right hand			
<p>Drawn left hand</p>	LR 877 LH SS	Satin Supreme™	870 mm x 700 mm - Toilet assist grab rail Add 55 mm for each capped extension. Complies with requirements of AS 1428.1-2009 for water closets. Stainless steel fixing screws supplied.
	LR 877 RH SS	Satin Supreme™	
	LR 877 LH PS	Polish Supreme™	
	LR 877 RH PS	Polish Supreme™	
960 mm x 600 mm TOILET ASSIST GRAB RAIL			
Please specify left or right hand			
<p>Drawn left hand</p>	LR 966 LH SS	Satin Supreme™	960 mm x 600 mm - Toilet assist grab rail Add 55 mm for each capped extension. Complies with requirements of AS 1428.1-2009 for water closets. Stainless steel fixing screws supplied.
	LR 966 RH SS	Satin Supreme™	
	LR 966 LH PS	Polish Supreme™	
	LR 966 RH PS	Polish Supreme™	
450 mm x 450 mm AMBULANT TOILET ASSIST GRAB RAIL			
Please specify left or right hand			
<p>Drawn left hand</p>	LR 454 LH SS	Satin Supreme™	450 mm x 450 mm - Ambulant assist grab rail Add 55 mm for each capped extension. Complies with requirements of AS 1428.1-2009 for water closets. Stainless steel fixing screws supplied.
	LR 454 RH SS	Satin Supreme™	
	LR 454 LH PS	Polish Supreme™	
	LR 454 RH PS	Polish Supreme™	
LINEAR GRAB RAIL/SHOWER KIT			
<p>Brass Friction Slide Cradle</p>	LF 900 J-C	Polish Supreme™	900 mm Polish Supreme™ stainless steel 304 grab rail with Brass Friction Slide Cradle for shower height adjustment. Also includes ABS Streamjet™ handpiece, PVC 1.5 m Silverflex® hose, soap dish and flow regulated wall outlet with licenced dual check. 3 Star - 9 L/min rated as per WELS licence number 0046. Complies with requirements for a 2 walled shower enclosure when installed with HS 700 PS as per AS 1428.1-2009.



TILTLOCK® FOLDING RAIL-WAYS®

SAFE-ASSIST® folding grab rails for toilets and showers for use by persons who suffer from sickness or disablement. The TILTLOCK® automatically locks when in the horizontal position and locks vertically as a support grab rail for standing patients. Fabricated with a chromed brass button release base housing, a solid brass concealed 4 fix wall "T" mount bracket and 304 stainless steel tube.

The TILTLOCK® SAFE-ASSIST® folding grab rail complies with clause 17 of AS 1428.1-2009 for Design and Construction. Tested by ANTL, test report 2945.11.



GRAB RAILS SHOULD BE MOUNTED SO THAT THE TOP OF THE RAIL IS 800 mm TO 810 mm ABOVE THE FLOOR.

850 mm x 185 mm x 32 mm dual bar folding grab rail with safety lock hinge mechanism. The TILTLOCK® automatically locks when in the horizontal position and locks vertically out of the way when not required. Fabricated with a chromed solid brass concealed wall mount with four fixing points and chromed brass button release housing with 304 stainless steel tube, giving a most pleasing finish.

M8 x 75, stainless steel hexagon coach screws and 10 mm wall plugs supplied with Tiltlock®

MUST BE FITTED TO A SOLID WALL OR OTHER FIRM SURFACE.

For other lengths, add \$5.00 per mm.

PATENT NUMBER: 2006100929

Code	Finish	Features
------	--------	----------

850 mm TILTLOCK® GRAB RAIL		Please specify left or right hand	
	TL 850 LH SS	Satin Supreme™	850 mm x 185 mm x 32 mm dual bar folding grab rail fabricated from 304 stainless steel with safety lock hinge mechanism. The TILTLOCK® with quick release automatically locks when in horizontal position and locks vertically out of the way when not required.
	TL 850 LH KG	Diamond Shur-Grip®	
	TL 850 LH WT	White	
	TL 850 RH SS	Satin Supreme™	NO EXPOSED NUTS OR BOLTS Stainless steel fixing screws supplied.
	TL 850 RH KG	Diamond Shur-Grip®	
	TL 850 RH WT	White	

Drawn left hand

850 mm TILTLOCK® GRAB RAIL WITH FLEXIBLE ABS TOILET ROLL HOLDER			
	TL 850T LH SS	Satin Supreme™	850 mm x 185 mm x 32 mm dual bar folding grab rail fabricated from 304 stainless steel with safety lock hinge mechanism. The TILTLOCK® with quick release automatically locks when in horizontal position and locks vertically out of the way when not required. Supplied with Flexible Fix ABS toilet roll holder fastened to grab rail.
	TL 850T LH KG	Diamond Shur-Grip®	
	TL 850T LH WT	White	
	TL 850T RH SS	Satin Supreme™	Supplied with Flexible ABS toilet roll holder fastened to grab rail.
	TL 850T RH KG	Diamond Shur-Grip®	
	TL 850T RH WT	White	

Flexible fix toilet roll holder - TR 031
Drawn left hand

850 mm TILTLOCK® GRAB RAIL WITH SS FIXED TOILET ROLL HOLDER			
	TL 850S LH SS	Satin Supreme™	850 mm x 185 mm x 32 mm dual bar folding grab rail fabricated from 304 stainless steel with safety lock hinge mechanism. The TILTLOCK® with quick release automatically locks when in horizontal position and locks vertically out of the way when not required.
	TL 850S LH KG	Diamond Shur-Grip®	
	TL 850S LH WT	White	
	TL 850S RH SS	Satin Supreme™	Supplied with 19 mm stainless steel toilet roll holder secured to grab rail.
	TL 850S RH KG	Diamond Shur-Grip®	
	TL 850S RH WT	White	

Drawn left hand

850 mm TILTLOCK® GRAB RAIL WITH NURSE CALL MOUNT BOX			
	TL 850N LH SS	Satin Supreme™	850 mm x 185 mm x 32 mm dual bar folding grab rail fabricated from 304 stainless steel with safety lock hinge mechanism. The TILTLOCK® with quick release automatically locks when in horizontal position and locks vertically out of the way when not required.
	TL 850N LH KG	Diamond Shur-Grip®	
	TL 850N LH WT	White	
	TL 850N RH SS	Satin Supreme™	Fitted with 304 stainless steel nurse call mount box. Nurse call switch not supplied with TILTLOCK®.
	TL 850N RH KG	Diamond Shur-Grip®	
	TL 850N RH WT	White	

Drawn left hand



SWINGLOCK® AND SIDE ASSIST RAIL-WAYS®

SAFE-ASSIST® dual bar, side swing grab rail for parallel cisterns and water closet designs when the toilet is installed in a corner requiring a grab rail each side of the pan. The SWINGLOCK® Hexagon F&M Lift/drop locking system eliminates bar sway, locks 45 degrees left or right hand and locks 90 degrees parallel with the wall when not required.



Optional extra: TR 031 Toilet roll holder

The SWINGLOCK® grab rails are in compliance with the general requirements for applications in hospitals, homes for the elderly and nursing homes. For water closet where the SWINGLOCK® is not suitable we recommend the TILTLOCK®.

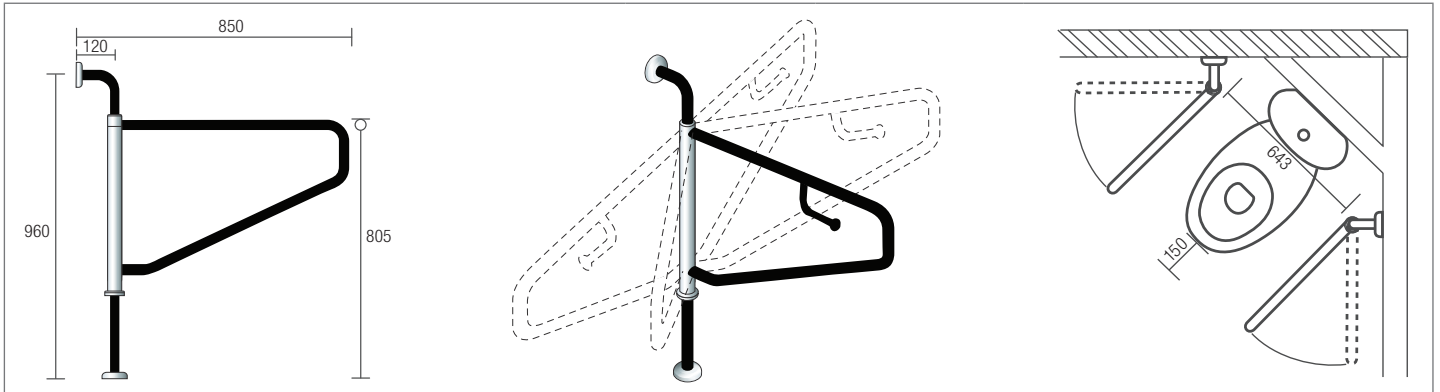

	Code	Finish	Features
850 mm SWINGLOCK® SIDE ASSIST RAIL			
	SL 850 SS	Satin Supreme™	850 mm x 805 mm dual bar SWINGLOCK® side swing grab rail. Fabricated from 304 stainless steel and assembled with 78 mm pre-formed domed CLAM FLANGE™. Stainless steel fixing screws supplied.
	WITH TOILET ROLL HOLDER		
	SL 850 S SS	Satin Supreme™	
WITH NURSE CALL HOOK			
SL 850 NH SS	Satin Supreme™		
850 mm x 800 mm x 450 mm TWIN ASSIST GRAB RAIL - SUITS EXPOSED & CONCEALED CISTERNS			
	CF 848 SS	Satin Supreme™	850 mm x 800 mm x 450 mm twin toilet assist grab rail with slide connecting bar to suit exposed and concealed cisterns. Fabricated from 304 stainless steel and assembled with 78 mm pre-formed domed CLAM FLANGE™. Stainless steel fixing screws supplied.
850 mm x 800 mm x 150 mm - GRAB RAIL WITH ROTATING SUPPORT LEG			
	CF 882 SS	Satin Supreme™	850 mm x 805 mm free standing grab rail with rotating support leg. Fabricated from 304 stainless steel and assembled with 78 mm pre-formed domed CLAM FLANGE™. Stainless steel fixing screws supplied.
	CF 882 PS	Polish Supreme™	
850 mm x 800 mm - FREE STANDING GRAB RAIL			
	CF 858 SS	Satin Supreme™	850 mm x 805 mm free standing grab rail. Fabricated from 304 stainless steel and assembled with 78 mm pre-formed domed CLAM FLANGE™. Stainless steel fixing screws supplied.



SAFE-ASSIST® FOLDING SHOWER SEATS

SAFE-ASSIST® folding shower seats for persons who suffer from sickness or disablement. Seat frames with tension grip hinge for horizontal and vertical movement are fabricated from 304 stainless steel and secured to the seat deck with concealed 316 stainless steel screws. Seat decks feature tamperproof, sanitary safe, Polar White, UV stabilised, High Density Polyethylene (HDPE) round edge with self draining channels.

SHOWER SEATS SHOULD BE MOUNTED SO THAT THE SEAT DECK IS 470 mm to 480 mm ABOVE THE FLOOR.



	Code	Finish	Features
SEAT SIZE - 960 mm x 400 mm - SHOWER SEAT COMPLIES WITH THE MINIMUM DESIGN, STRENGTH AND DIMENSION REQUIREMENTS OF AS 1428.1-2009			
	SS 964 SS	Satin Supreme™	Seat size: 960 mm x 400 mm Grade 304 stainless steel frame with Polar White High Density Polyethylene (HDPE) seat deck with self draining channels. Complies with requirements of AS 1428. 1-2009 for a 2 walled shower enclosure. Stainless steel fixing screws supplied. MAX. LOAD: 160 Kg (25 stone)
	SS 964 PS	Polish Supreme™	
SEAT SIZE - 960 mm x 400 mm - SHOWER SEAT COMPLIES WITH THE MINIMUM DESIGN, STRENGTH AND DIMENSION REQUIREMENTS OF AS 1428.1-2009			
	SS 964 WM	Satin Supreme™	WHEELCHAIR TRANSFER SEAT. Seat size: 960 mm x 400 mm seat supported by heavy duty Tension Grip hinge brackets. Most suitable for convenient transfer between wheelchair and shower seat. Assembled with Polar White, UV stabilised, fade resistant, High Density Polyethylene (HDPE) seat deck with self draining channels. Complies with requirements of AS 1428.1-2009 for a 2 walled shower enclosure. Stainless steel fixing screws supplied. MAX. LOAD: 160 Kg (25 stone) INSTALLATION HEIGHT OF SEAT: 470 mm - 480 mm
SEAT SIZE - 960 mm x 400 mm - SHOWER SEAT COMPLIES WITH THE MINIMUM DESIGN, STRENGTH AND DIMENSION REQUIREMENTS OF AS 1428.1-2009			
	SS 964 CW	Satin Supreme™	DESIGNED FOR BATHROOMS WITH COVERED WALLS. Seat size: 960 mm x 400 mm seat with 100 mm x 60 mm covered plated rear legs for fixing to floor with 10 mm front leg Acetyl plugs to suit shower cubical gradient. Assembled with Polar White, UV stabilised, fade resistant, High Density Polyethylene (HDPE) seat deck with self draining channels. Complies with requirements of AS 1428.1-2009 for a 2 walled shower enclosure. Stainless steel fixing screws supplied. MAX. LOAD: 160 Kg (25 stone)
SEAT SIZE - 960 mm x 400 mm - SHOWER SEAT COMPLIES WITH THE MINIMUM DESIGN, STRENGTH AND DIMENSION REQUIREMENTS OF AS 1428.1-2009			
	SS 964 MSS	Stainless Steel	Seat size: 960 mm x 400 mm Seat frame and 3 part slatted seat deck fabricated from 304 stainless steel. Powder coated totally white. Other colours available on request. Complies with requirements of AS 1428.1-2009 for a 2 walled shower enclosure. Stainless steel fixing screws supplied. MAX. LOAD: 160 Kg (25 stone)
	SS 964 MWT	White	
STANDARD FIXING - STUD WALLS Use the 4 x stainless steel M8 x 75 mm coach screws supplied. Fix seat with the coach screws into wall studs or nogging. Shower seats must be fitted to a solid wall or into stud construction. Wall surface must be flat.		STANDARD FIXING - MASONRY WALLS Use the 4 x stainless steel M8 x 75 mm coach screws and plugs supplied. Fix seat with wall plugs and coach screws onto wall. The installer should ensure that the nature of the wall will provide a firm fixing for all screws supporting the shower seat.	



SAFE-ASSIST® PURPOSE BUILT SHOWER SEATS

SAFE-ASSIST® folding shower seats for persons who suffer from sickness or disablement. Seat frames with tension grip hinge for horizontal and vertical movement are fabricated from 304 stainless steel and secured to the seat deck with concealed 316 stainless steel screws. Seat decks feature tamperproof, sanitary safe, Polar White, UV stabilised, High Density Polyethylene (HDPE) round edge with self draining channels.

SHOWER SEATS SHOULD BE MOUNTED SO THAT THE SEAT DECK IS 470 mm to 480 mm ABOVE THE FLOOR.

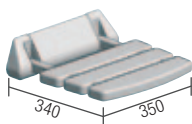
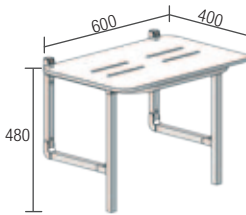
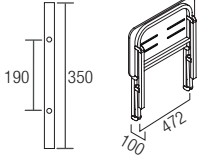
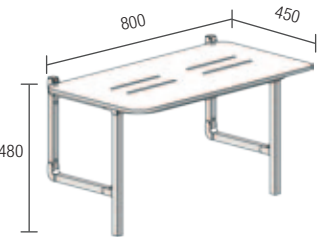
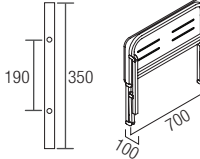
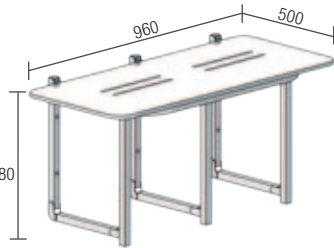
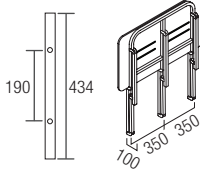
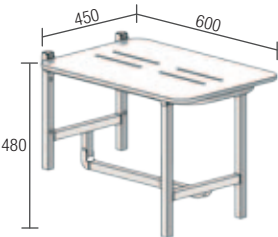
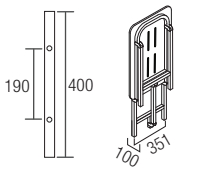

	Code	Finish	Features
SEAT SIZE - 350 mm x 340 mm - FOR AREAS NOT STRICTLY DISABLED			
	SS 220 WT	White	Seat size: 350 mm wide by 340 mm deep fold-away ABS white slatted shower seat with strong aluminium support struts and wall fixing bracket. Designed to be fitted to a solid wall or other firm surface inside a shower cubicle or over a bath. Has many usages. Stainless steel fixing screws supplied. MAX. LOAD: 115 Kg (18 stone)
SEAT SIZE - 600 mm x 400 mm - FOR AREAS NOT STRICTLY DISABLED			
	SS 604 SS	Satin Supreme™	Seat size: 600 mm x 400 mm Grade 304 stainless steel frame with Polar White High Density Polyethylene (HDPE) seat deck with self draining channels. Stainless steel fixing screws supplied. MAX. LOAD: 160 Kg (25 stone)
	SS 604 PS	Polish Supreme™	
	SS 604 MSS	Stainless Steel	
			 Wall Bracket Dimension
SEAT SIZE - 800 mm x 450 mm - MEETS NEW ZEALAND STANDARDS NZS 4121:2001			
	SS 845 SS	Satin Supreme™	Seat size: 800 mm x 450 mm Grade 304 stainless steel frame with Polar White High Density Polyethylene (HDPE) seat deck with self draining channels. Stainless steel fixing screws supplied. MAX. LOAD: 160 Kg (25 stone)
			 Wall Bracket Dimension
SEAT SIZE - 960 mm x 500 mm - BARIATRIC SEAT FOR AREAS NOT STRICTLY DISABLED			
	SS 965 BS	Satin Supreme™	LARGE SHOWER SEAT WITH ADDITIONAL CENTRE SUPPORT TO ACCEPT HEAVIER LOAD. Seat size: 960 mm x 500 mm wide BARIATRIC seat with centre legs so as to take more weight. Assembled with Polar White, UV stabilised, fade resistant, High Density Polyethylene (HDPE) seat deck with self draining channels. Stainless steel fixing screws supplied. MAX. LOAD: 200 Kg (32 stone)
			 Wall Bracket Dimension
SEAT SIZE - 600 mm x 450 mm - SHOWER SEAT FOR LIMITED WALL AREAS NOT STRICTLY DISABLED			
	SS 645 SL	Satin Supreme™	DESIGNED FOR OPPOSING WALL OPEN ENDED SHOWER ENCLOSURE AND SITUATIONS WHERE A WALL IS NOT WIDE ENOUGH TO ACCOMMODATE PRIOR ART FOLDABLE SEATS. Seat size: Side lift, 600 mm x 450 mm shower seat, assembled with Polar White, UV stabilised, fade resistant, High Density Polyethylene (HDPE) seat deck with self draining channels. Stainless steel fixing screws supplied. MAX. LOAD: 160 Kg (25 stone)
			 Wall Bracket Dimension

Bariatric seat - Designed for heavier loads

Seat lifts side ways to wall
Patent Number: 2008100882

STANDARD FIXING - STUD WALLS

Use the 4 x stainless steel M8 x 75 mm coach screws supplied.
Fix seat with the coach screws into wall studs or nogging.
Shower seats must be fitted to a solid wall or into stud construction.
Wall surface must be flat.

STANDARD FIXING - MASONRY WALLS

Use the 4 x stainless steel M8 x 75 mm coach screws and plugs supplied.
Fix seat with wall plugs and coach screws onto wall.
The installer should ensure that the nature of the wall will provide a firm fixing for all screws supporting the shower seat.



Safe-Assist® BACKREST for Healthcare Applications

The BACKREST, a support device for toilets, bidets and the like, introduced into the Australian Standard for Access and Mobility to comply with the changing requirements for sanitary facilities.

The BACKREST provides a support that improves the comfort of using a toilet while simultaneously providing an acceptable level of safety for disabled, aged and infirmed.

Con-Serv® patented BACKREST options as shown are compatible with all cisterns. But due to the different dimensions in cistern design, it is essential to select the correct BACKREST option to comply with the Australian Access and Mobility Standard AS 1428.1-2009 for single (Figure 52 of AS 1428.1-

2009) or combined (Figure 50 of AS 1428.1-2009) sanitary compartments.

Tested by the Australian National Testing Laboratories Pty Ltd (ANTL) as outlined in clause 15.2.4 BACKREST of AS 1428.1-2009, careful selection from the Con-Serv® Safe-Assist® BACKREST range will ensure full compliance with the Australian Standards requirement. Floor mount BACKREST test report – 3104.11 and Wall Mount BACKREST test report – 3411.11

For further information, refer to the BACKREST Suitability Guide or contact our Technical Product Adviser on the Priority Phone Number – 1300 467 322.



Safe-Assist® BACKREST Options



Model - BR 395
PATENT NUMBER 2010100132

Suits all standard accessible suites. Ideally suited to applications when fastening to rear wall is not an option. E.g. vinyl walls or insufficient bracing.



Model - BR 400
PATENT NUMBER 2010101409

Adjusts to suit cisterns from 340 mm to 476 mm width, while still allowing the unimpeded installation and access to other grab rails at side of pan as per requirements of AS 1428.1-2009 (fig 42).



Model - BR 440
PATENT NUMBER 2010101409

Flexible installation left or right side of cisterns from 340 mm to 476 mm width and includes an additional 400 mm grab rail extension as per requirements of AS 1428.1-2009 (fig 42).

SUITABILITY GUIDE	BR 395	BR 400	BR 440
Sanitary Compartment with Conventional Pan	•	•	•
Sanitary Compartment with Wall Faced Pan		•	•
Sanitary Compartment with Shower and Conventional Pan	•	•	
Sanitary Compartment with Shower and Wall Faced Pan		•	



SAFE-ASSIST® - BACKREST

SAFE-ASSIST® BACKREST support for single toilet suites and combined PWD sanitary compartments.

Robust designed 32 mm grade 304 stainless steel Backrest. Fabricated with a choice of 78 mm domed CLAM FLANGE™ or 50 mm HYGIENIC SEAL® healthsafe flange cover. The Backrest features a 96° tamperproof, sanitary safe, Polar White, UV stabilised High Density Polyethylene (HDPE) rounded edge back support.

AS 1428.1



Complies as per the requirements of AS 1428.1-2009 section 15.2.4-BACKREST.

Code Finish Features

BR 395 - FLOOR MOUNTED BACKREST

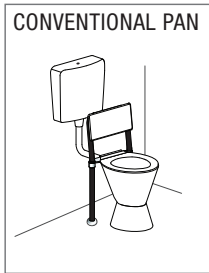
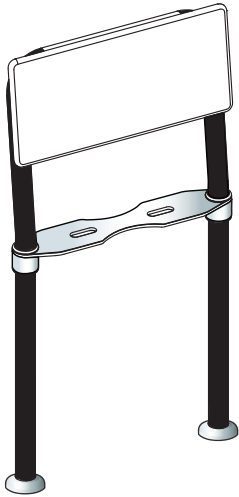

Patent Number 2010100132

BR 395 SS	Satin Supreme™
BR 395 PS	Polish Supreme™

- Suits all standard accessible suites. (Not wall faced pans)
- For single PWD cubicle with conventional pan.
- For combined PWD sanitary compartment with conventional pan and shower recess grabrail.
- Fixed to floor with triple screw floor mount and screw on sealed healthsafe flange covers.
- Stainless steel fixing screws supplied.

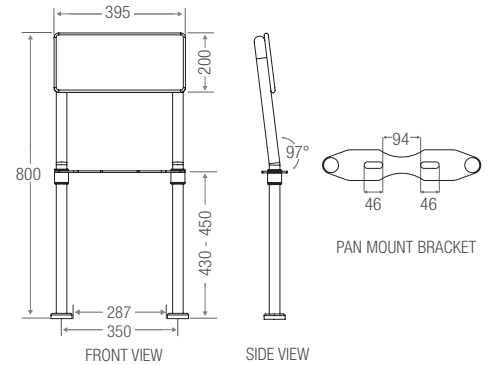

BR 400 - WALL MOUNTED BACKREST

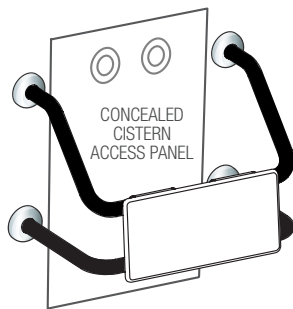

Patent Number 2010101409

CLAM FLANGE™	
BR 400 CF SS	Satin Supreme™
BR 400 CF PS	Polish Supreme™

HYGIENIC SEAL®	
BR 400 HS SS	Satin Supreme™
BR 400 HS PS	Polish Supreme™

- For single PWD cubicle with conventional pan.
- For single PWD cubicle with wall faced pan.
- For combined PWD sanitary compartment with conventional pan and shower recess grab rail.
- For combined PWD sanitary compartment with wall faced pan and shower recess grab rail.
- Also suitable for concealed cisterns.
- Stainless steel fixing screws supplied.

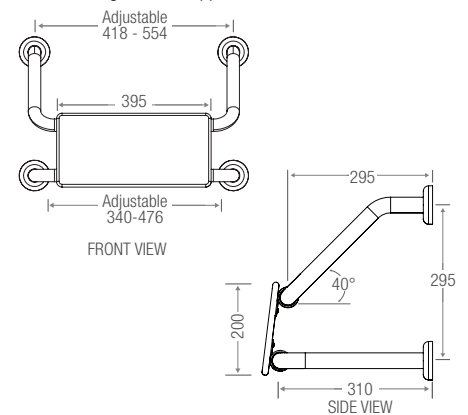

BR 440 - WALL MOUNTED BACKREST WITH 400 mm EXTENSION

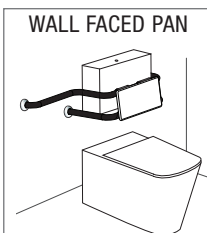
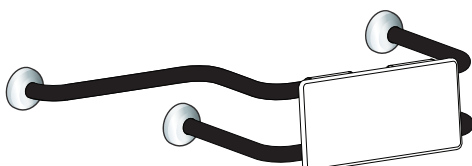

Patent Number 2010101409

CLAM FLANGE™	
BR 440 CF SS	Satin Supreme™
BR 440 CF PS	Polish Supreme™

HYGIENIC SEAL®	
BR 440 HS SS	Satin Supreme™
BR 440 HS PS	Polish Supreme™

- For single PWD cubicle with conventional pan.
- For single PWD cubicle with wall faced pan.
- The adjustable 400 mm extended mount can be installed on the left or right hand side of cistern.
- Stainless steel fixing screws supplied.

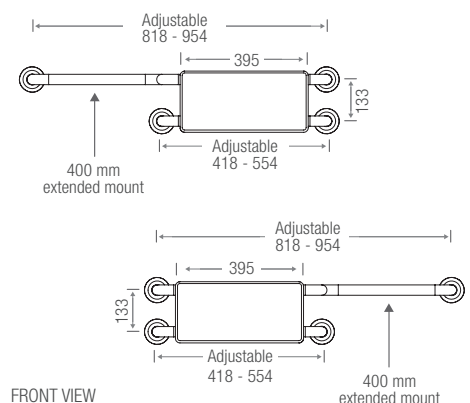



Safe-Assist® ANTI-LIGATURE GRAB RAILS

Bars for High Risk Applications

Specially designed 38 mm Anti-Ligature grab rails with barrier manufactured from grade 304 stainless steel for use in water closets and other assist requirement areas to eliminate the possibility of self harm by patients or inmates in psychiatric clinics, hospitals and detention facilities.

Generally meets the requirement of AS 1428.1-2009.



	Code	Finish	Features
VERTICAL ANTI-LIGATURE GRAB RAILS			
	AL 1500 V SS	Satin Supreme™	The anti-ligature barrier on the 38 mm vertical grab rail is a 2.5 mm grade 304 stainless steel plate which is centered 55 mm from back of rail to wall and continuously welded from flange to flange, giving improved access and grip ability on the grab rail.
	AL 900 V SS	Satin Supreme™	Manufactured with exposed flanges. Tamperproof stainless steel 14# x 1½" POST TORX screws supplied.
	AL 600 V SS	Satin Supreme™	
	AL 450 V SS	Satin Supreme™	
			<p>SECTION VIEW</p>

HORIZONTAL ANTI-LIGATURE GRAB RAILS			
	AL 450 H SS	Satin Supreme™	The anti-ligature barrier on the 38 mm horizontal grab rail is a 2.5 mm grade 304 stainless steel square section which is centered 74 mm from the underpart of the rail to wall and continuously welded from end to end giving a 55 mm access and grip ability on the grab rail.
	AL 600 H SS	Satin Supreme™	Tamperproof stainless steel 14# x 1½" POST TORX screws supplied.
	AL 900 H SS	Satin Supreme™	
	AL 1500 H SS	Satin Supreme™	
			<p>SECTION VIEW</p>



SAFE-ASSIST® ANTI-LIGATURE GRAB RAILS

Specially designed 38 mm toilet assist Anti-Ligature grab rails with combined vertical and horizontal barriers, manufactured from 304 stainless steel for use in water closets with concealed or exposed cisterns to eliminate the possibility of self harm by patients or inmates in psychiatric clinics, hospitals and detention facilities.

Generally meets the requirements of AS 1428.1-2009.



	Code	Finish	Features
90° ANTI-LIGATURE TOILET ASSIST GRAB RAILS			
Please specify left or right hand			
<p>Drawn left hand For ambulant disabilities</p>	AL 454 LH SS	Satin Supreme™	450 mm x 450 mm LEFT HAND, 38 mm Anti-Ligature grade 304 stainless steel toilet assist grab rail with 30 mm combined underpart horizontal square section and 2.5 mm centered back plate both continuously welded to rail, giving a 55 mm access and grip ability on the grab rail. Manufactured with exposed flanges. Tamperproof stainless steel 14# x 1½" POST TORX screws supplied.
90° ANTI-LIGATURE TOILET ASSIST GRAB RAILS			
Please specify left or right or centre fix			
<p>Drawn right hand For ambulant disabilities</p>	AL 454 RH SS	Satin Supreme™	450 mm x 450 mm RIGHT HAND, 38 mm Anti-Ligature grade 304 stainless steel toilet assist grab rail with 30 mm combined underpart horizontal square section and 2.5 mm centered back plate both continuously welded to rail, giving a 55 mm access and grip ability on the grab rail. Manufactured with exposed flanges. Tamperproof stainless steel 14# x 1½" POST TORX screws supplied.
90° ANTI-LIGATURE TOILET ASSIST GRAB RAILS			
Please specify left or right hand			
<p>Drawn left hand</p>	AL 966 LH SS	Satin Supreme™	960 mm x 600 mm LEFT HAND, 38 mm Anti-Ligature grade 304 stainless steel toilet assist grab rail with 30 mm combined underpart horizontal square section and 2.5 mm centered back plate both continuously welded to rail, giving a 55 mm access and grip ability on the grab rail. Manufactured with exposed flanges. Tamperproof stainless steel 14# x 1½" POST TORX screws supplied.
90° ANTI-LIGATURE TOILET ASSIST GRAB RAILS			
Please specify left or right hand			
<p>Drawn right hand</p>	AL 966 RH SS	Satin Supreme™	960 mm x 600 mm RIGHT HAND, 38 mm Anti-Ligature grade 304 stainless steel toilet assist grab rail with 30 mm combined underpart horizontal square section and 2.5 mm centered back plate both continuously welded to rail, giving a 55 mm access and grip ability on the grab rail. Manufactured with exposed flanges. Tamperproof stainless steel 14# x 1½" POST TORX screws supplied.

SPECIAL MAKE ANTI-LIGATURE GRAB RAILS CAN BE MANUFACTURED ON REQUEST TO SPECIFICATIONS
NON RETURNABLE



CIRCULATION SPACE & POSITION OF GRAB RAILS IN WATER CLOSETS



FIGURE 43 - CIRCULATION SPACE FOR WC PAN - RIGHT HAND TRANSFER (LEFT HAND TRANSFER IS MIRROR REVERSED)

Plan

Due to licensing restrictions Con-Serv is unable to provide this information in a digital version. For a printed version please contact us.

LEGEND:  Circulation space

FIGURE 42 - POSITIONS OF GRAB RAILS IN WATER CLOSETS

Elevation

Due to licensing restrictions Con-Serv is unable to provide this information in a digital version. For a printed version please contact us.



SIDE VIEW SHOWING OPTIONAL SYSTEMS FOR GRAB RAILS AT SIDE OF PAN

Horizontal grab rails should be mounted so that the top of the rail is 800 mm to 810 mm above the floor level. Rails fitted with CLAM FLANGE™ or HYGIENIC SEAL® on request. Toilet assist grab rails in this section comply strictly with the minimum design, strength and dimension requirements of AS 1428.1-2009.

Complies as per requirements of AS 1428.1-2009 section 15.2.6, figure 41, ZONE FOR THE POSITION OF TOILET PAPER DISPENSER.



FIGURE 42 - FOR USE IN WATER CLOSETS WITH EXPOSED CISTERNS

ELEVATION - OPTION A

Please specify left or right hand

- 1 x HS 877 SS 870 mm x 700 mm grab rail
- 1 x HS 300 SS 300 mm straight grab rail

Due to licensing restrictions Con-Serv is unable to provide this information in a digital version. For a printed version please contact us.

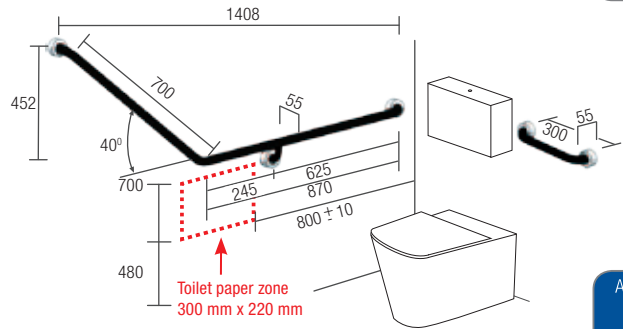

Drawn right hand
Drawing not to scale.



FIGURE 42 - FOR USE IN WATER CLOSETS WITH EXPOSED CISTERNS

ELEVATION - OPTION B

Please specify left or right hand

- 1 x HS 966 SS 960 mm x 600 mm grab rail
- 1 x HS 300 SS 300 mm straight grab rail

Due to licensing restrictions Con-Serv is unable to provide this information in a digital version. For a printed version please contact us.

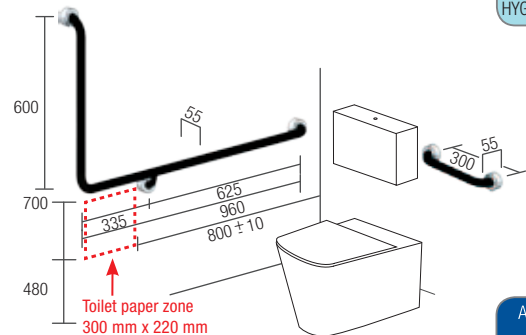

Drawn right hand
Drawing not to scale.



FOR USE IN WATER CLOSETS WITH CONCEALED CISTERNS

OPTION A

HS 197 SS 1110 mm x 940 mm x 700 mm

OPTION B

HS 116 SS 1100 mm x 1030 mm x 600 mm

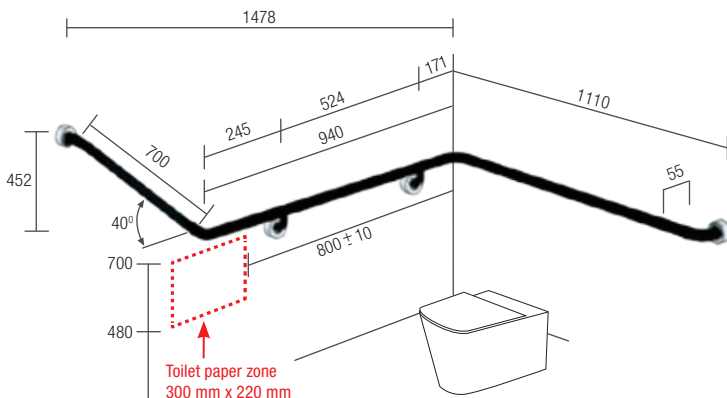

Drawn right hand
Drawing not to scale.

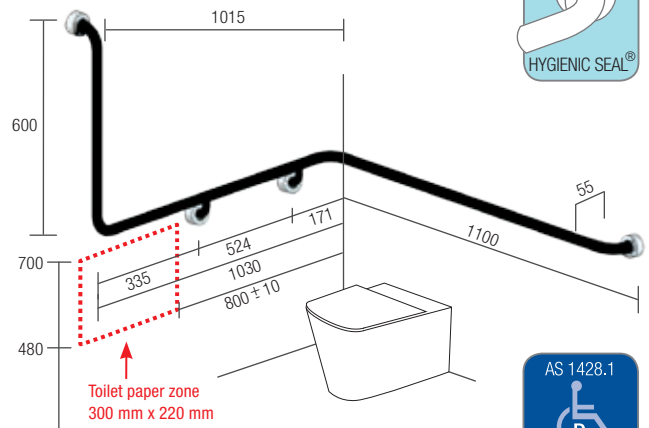

Drawn right hand
Drawing not to scale.





SYSTEMS FOR PEOPLE WITH DISABILITIES (PWD)

2 WALLED SHOWER ENCLOSURE

Grab rails, Shower support rails and the Shower seat in this section comply strictly with the minimum design, strength and dimension requirements of AS 1428.1-2009, Design for Access and Mobility. Shower seats should be mounted so that the top of the seat is 470 mm to 480 mm above the floor.

Mount horizontal section of rail 800 mm to 810 mm above floor level.

FIGURE 47 - SHOWER RECESS CIRCULATION SPACE

Plan

Due to licensing restrictions Con-Serv is unable to provide this information in a digital version. For a printed version please contact us.

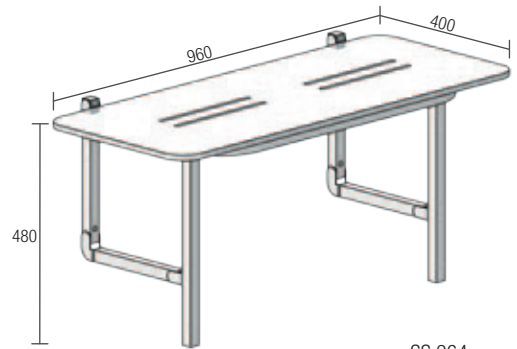
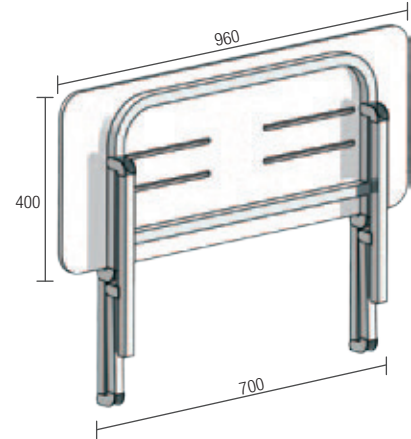

LEGEND:  Circulation space

FIGURE 48 - SHOWER RECESS FITTINGS

Elevation

Due to licensing restrictions Con-Serv is unable to provide this information in a digital version. For a printed version please contact us.



OPTIONS FOR USE IN 2 WALLED SHOWER ENCLOSURE

3 STAR - 9 L/min as per WELS licence number - 0046. Horizontal grab rails should be mounted so that the top of the rail is 800 mm to 810 mm above the floor level. Rails fitted with HYGIENIC SEAL® flange.



OPTION A ID 018-3 INDEPENDENT HOSFAB® - PWD

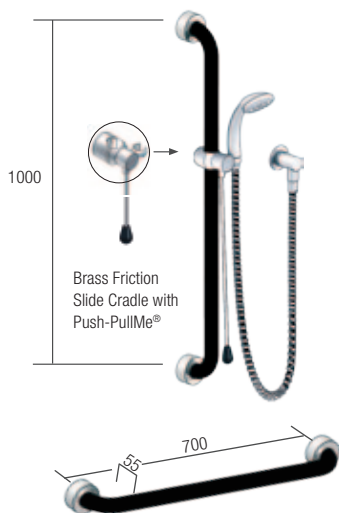

Code	Description
ID 018 KIT 3	<ul style="list-style-type: none"> Independent accessible 1000 mm handheld shower/grab rail combination with PUSH-PULLME® showerhead height adjustment rod for seated persons. Requires an additional 700 mm grab rail, The PUSH-PULLME® allows the graspable portion of the shower head to be positioned at various angles and heights between 1000 mm and 1800 mm above the floor and allows access and adjustment from a seated position. Complies with requirements of AS 1428.1-2009 for persons with disabilities (PWD). Licensed dual check/non-return valve.
AND	
1 x HS 700 SS	

INDICATIVE IMAGE ONLY
(Refer to page 54, figure 48 for recommended positioning)

OPTION B ID 020-L INDEPENDENT HOSFAB® - PWD LEFT HAND

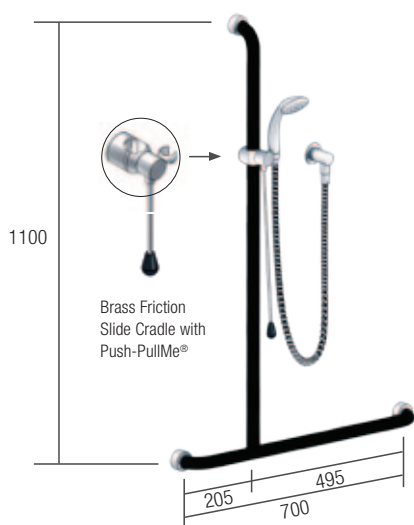

ID 018 KIT 20L	<ul style="list-style-type: none"> Independent accessible 700 mm x 1100 mm, LEFT HAND inverted "T" handheld shower/grab rail combination with PUSH-PULLME® showerhead, height adjustment rod for seated persons. The PUSH-PULLME® allows the graspable portion of the shower head to be positioned at various angles and heights between 1000 mm and 1800 mm above the floor and allows access and adjustment from a seated position. Complies with requirements of AS 1428.1-2009 for persons with disabilities (PWD). Licensed dual check/non-return valve.

INDICATIVE IMAGE ONLY
(Refer to page 54, figure 48 for recommended positioning)

Drawn left hand

OPTION C ID 020-R INDEPENDENT HOSFAB® - PWD RIGHT HAND

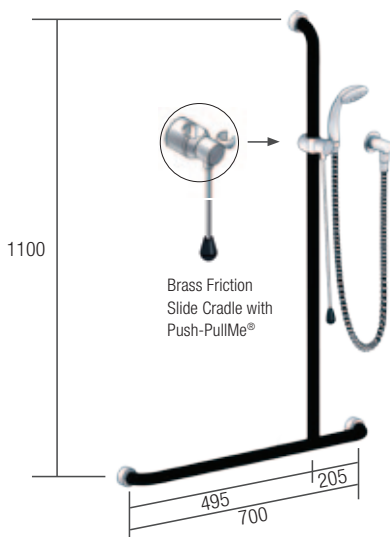

ID 018 KIT 20R	<ul style="list-style-type: none"> Independent accessible 700 mm x 1100 mm, RIGHT HAND inverted "T" handheld shower/grab rail combination with PUSH-PULLME® showerhead, height adjustment rod for seated persons. The PUSH-PULLME® allows the graspable portion of the shower head to be positioned at various angles and heights between 1000 mm and 1800 mm above the floor and allows access and adjustment from a seated position. Complies with requirements of AS 1428.1-2009 for persons with disabilities (PWD). Licensed dual check/non-return valve.

INDICATIVE IMAGE ONLY
(Refer to page 54, figure 48 for recommended positioning)

Drawn right hand



SYSTEMS FOR PEOPLE WITH DISABILITIES (PWD) TO SUIT COMBINED ACCESSIBLE SANITARY COMPARTMENT

Grab rails, shower support rails and the shower seat in this section comply strictly with the minimum design, strength and dimension requirements of AS 1428.1-2009, Design for Access and Mobility. Shower seats should be mounted so that the top of the seat is 470 mm to 480 mm above the floor. Mount horizontal section of rail 800 mm to 810 mm above floor level.



FIGURE 50 - SHOWER RECESS CIRCULATION SPACE

Plan

Due to licensing restrictions Con-Serv is unable to provide this information in a digital version. For a printed version please contact us.

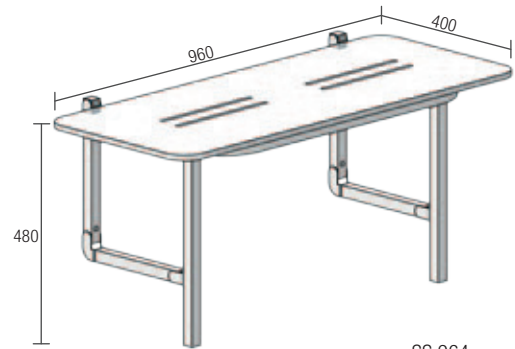
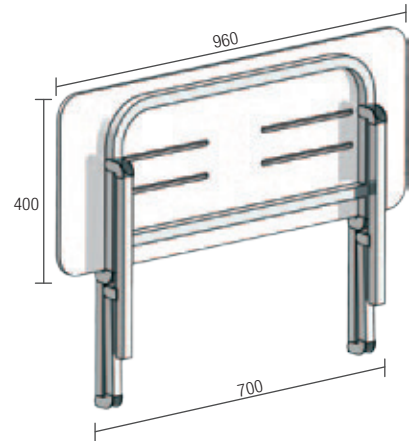

SS 964

FIGURE 50 - SHOWER RECESS ELEVATION

Elevation

Due to licensing restrictions Con-Serv is unable to provide this information in a digital version. For a printed version please contact us.



OPTIONS FOR USE TO SUIT

COMBINED ACCESSIBLE SANITARY COMPARTMENT

3 STAR - 9 L/min as per WELS licence number - 0046. Horizontal grab rails should be mounted so that the top of the rail is 800 mm to 810 mm above the floor level. Rails fitted with HYGIENIC SEAL® flange.



WaterMark
AS/NZS 3662
WMKT 21147



OPTION A ID 018-3 INDEPENDENT HOSFAB® - PWD

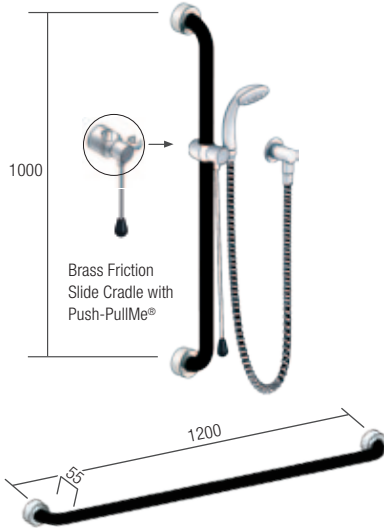

Code Description

ID 018 KIT 3
AND
1 x HS 1200 SS

- Independent accessible 1000 mm handheld shower/grab rail combination to suit Combined Accessible Sanitary Compartment with PUSH-PULLME® shower head height adjustment rod for seated persons.
- Requires an additional 1200 mm grab rail.
- The PUSH-PULLME® allows the graspable portion of the shower head to be positioned at various angles and heights between 1000 mm and 1800 mm above the floor and allows access and adjustment from a seated position.
- Complies with requirements of AS 1428.1-2009 for persons with disabilities (PWD).
- Licenced dual check/non-return valve.

INDICATIVE IMAGE ONLY
(Refer to page 56, figure 50 for recommended positioning)



OPTION B ID 018-21L INDEPENDENT HOSFAB® - PWD LEFT HAND

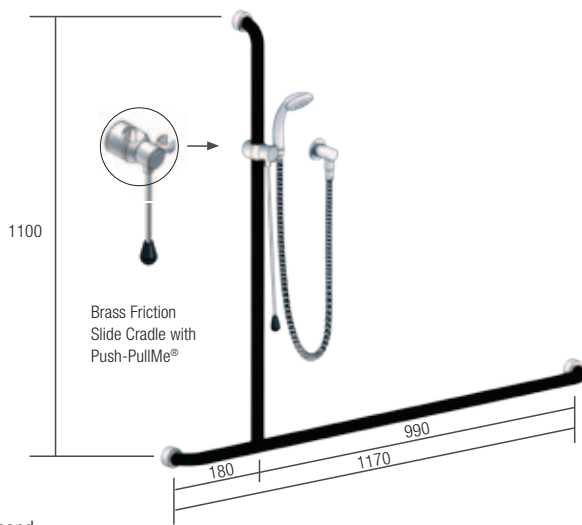

ID 018 KIT 21L

- Independent accessible 1170 mm x 1100 mm, LEFT HAND inverted "T" handheld shower/grab rail combination to suit Combined Accessible Sanitary Compartment with PUSH-PULLME® shower head height adjustment rod for seated persons.
- The PUSH-PULLME® allows the graspable portion of the shower head to be positioned at various angles and heights between 1000 mm and 1800 mm above the floor and allows access and adjustment from a seated position.
- Complies with requirements of AS 1428.1-2009 for persons with disabilities (PWD).
- Licenced dual check/non-return valve.

INDICATIVE IMAGE ONLY
(Refer to page 56, figure 50 for recommended positioning)

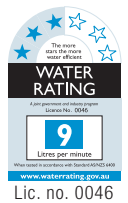

Drawn left hand

OPTION C ID 018-21R INDEPENDENT HOSFAB® - PWD RIGHT HAND

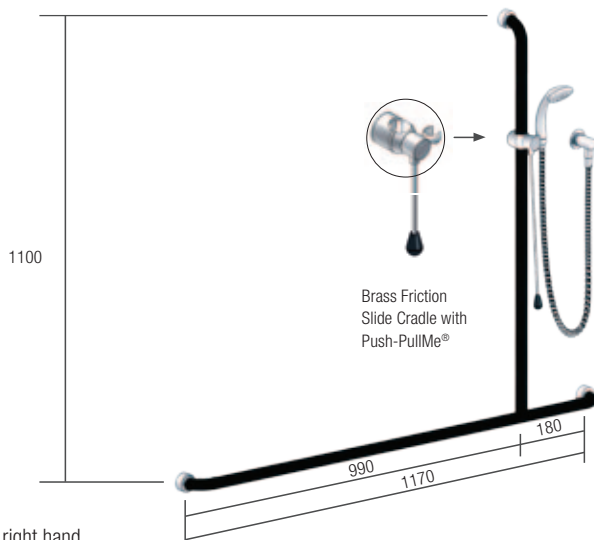

ID 018 KIT 21R

- Independent accessible 1170 mm x 1100 mm, RIGHT HAND inverted "T" handheld shower/grab rail combination to suit Combined Accessible Sanitary Compartment with PUSH-PULLME® shower head height adjustment rod for seated persons.
- The PUSH-PULLME® allows the graspable portion of the shower head to be positioned at various angles and heights between 1000 mm and 1800 mm above the floor and allows access and adjustment from a seated position.
- Complies with requirements of AS 1428.1-2009 for persons with disabilities (PWD).
- Licenced dual check/non-return valve.

INDICATIVE IMAGE ONLY
(Refer to page 56, figure 50 for recommended positioning)



Drawn right hand



About Stainless Steel Grab Rails

Alloy Types

304 is the basic chromium-nickel austenitic stainless steel and has been found suitable for a wide range of applications. It is the most readily available in a variety of product forms. This grade is easy to form and fabricate and is resistant to corrosion.

304L is the low carbon version of 304. The use of the letter "L" after the grade number means that the carbon content is restricted to a maximum of 0.03% (normal levels are 0.08%). The lower level of carbon is usually used where welding is performed and helps to prevent the chromium from being depleted so it can form the "passive" oxide layer, giving excellent resistance to corrosion and metallurgically incapable of rusting.

316 offers more corrosion-resistance through the addition of molybdenum, this grade is desirable where the possibility of severe corrosion exists, such as marine environments.

316L is the low carbon version of 316.

What Does 18/8 Mean

The first number is the amount of chromium that is contained in the stainless. The second number is the amount of nickel. So 18/8 means that this stainless steel contains 18% chromium and 8% nickel and is part of the grade family "300 series" stainless which is non-magnetic.

Care of Stainless Steel

To have an optimum corrosion resistant stainless steel, surfaces must be clean and have an adequate supply of oxygen to maintain their 'passive' surface layer. Passive Film is invisible in stainless steel. It's created when oxygen combines with chromium in the stainless to form chromium oxide.

Stainless steel supplied by reputable manufacturers or fabricators will normally be clean and contamination free. Generally, stubborn stains and discolouration corrosion

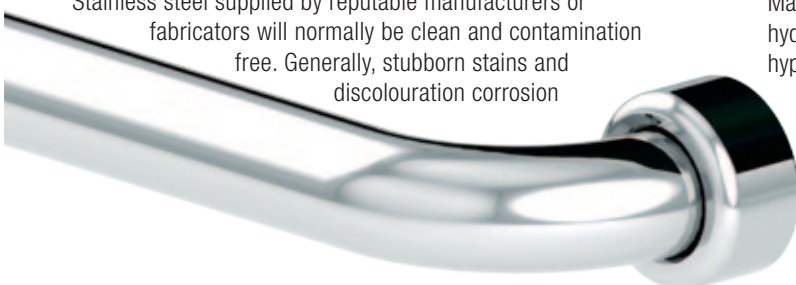

occurs when there is an overall breakdown of the 'passive' film, due to incorrect cleaning procedures. Rust staining can occur as anything from a slight brown 'bloom' on the surface to severe surface pitting or rusty scour marks on items such as GRAB RAILS and HAND RAILS. Cleanliness and stainless steel are closely related in many applications and each is dependent upon the other. Cleanliness is essential for maximum resistance to corrosion.

The Cleaning of Stainless Steel

Alkali cleaners such as baking soda or ammonia are effective to clean stainless steel. Always attempt the mildest cleaning method first. Stainless steel's best friends are quite simply soap, mild detergent or ammonia solution in warm water applied with a soft cloth or nylon sponge for polished finishes followed by a clean water rinse. Dry wipe eliminates the possibility of water stains. Occasionally, the use of the least coarse nylon scouring pad may be required for satin finishes.

What to Avoid

Do not use ordinary steel wool. Iron particles can become embedded in stainless steel and cause 'iron' contamination.

Do not use chlorides or acids as they are reactive to stainless steel. Strong acid solutions like hydrochloric acid or "spirit of salts" are sometimes used to clean masonry and tiling of new bathrooms and toilets, but they should NEVER be permitted to come into contact with metals, INCLUDING STAINLESS STEEL.

Halogen salts, especially chlorides easily penetrate the "passive film" of stainless steel and will allow corrosive attack to occur. The halogens are easy to recognize because they end in the letters "INE". Listed in order of their activity are:

- Fluorine
- Chlorine
- Bromine
- Iodine
- Astatine

Never use brick cleaning liquids which contain hydrochloric acid. Many cleaning solutions and solvents contain chlorinated hydrocarbons. If a cleaner containing chlorides, bleaches and hypochlorites are used, it must be promptly and thoroughly cleaned off.

Please note: The Con-Serv warranty on grab rails will be null and void should they be exposed to chemical corrosion due to incompetent cleaning practices.



8th edition

grab rail manual



Protecting the world's most valuable liquid asset... water!



CON-SERV CORPORATION AUSTRALIA PTY. LTD.
17 Glentanna Street, Kedron · Qld. 4031 Australia
Phone: +61 (0)7 3630 5744 · Fax: +61 (0)7 3630 5755
E-mail: mail@con-serv.com.au · www.con-serv.com.au